



# CROOKED RIVER

## BUILDING SUPPLY

### STOCK PRODUCT CATALOG VOLUME II



*19106 Miles Road Warrensville Heights, OH 44128*



216-478-9700



Showroom@CrookedRiverSupply.com

[www.CrookedRiverBuildingSupply.com](http://www.CrookedRiverBuildingSupply.com)

# NOW STOCKING



# SmartSide®

TRIM & SIDING

ADVANCED  
DURABILITY FOR  
LONGER LASTING  
BEAUTY®

Our Stock Color Options



Contact us or visit our showroom to discover how LP Smart Side can enhance your home.

LP Siding has redefined traditional building materials with treated engineered wood products that are designed to offer game-changing durability, beauty and workability. LP is a building industry leader in a category that's shaping the way homes, outdoor building structures and light commercial properties are being built. LP products elevate almost any structure—from traditional homes to modern masterpieces. Its versatility also offers endless options for designs that stand out.

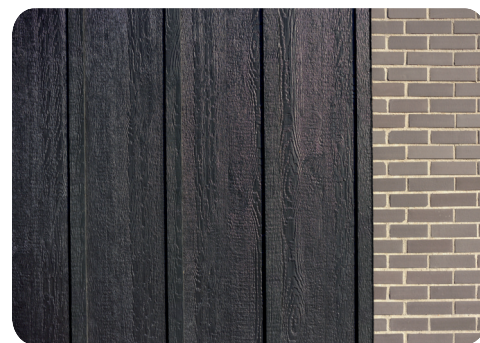

# STOCK PRODUCT CATALOG, VOLUME II

## **INDEX**

### *Mouldings*

Casing .....	2-4
Back Band .....	5
Base Board .....	6-8
Base Cap .....	8
Shoe .....	9
Crown .....	10-14
Chair Rail .....	15
Panel .....	16-17
Miscellaneous .....	18-19
Tongue & Groove/Shiplap .....	19

<i>Sheet Goods</i> .....	20
--------------------------	----

<i>Interior Doors</i> .....	21-28
-----------------------------	-------

### *Stair Parts*

Hand Rail .....	29-30
Newel Posts .....	31
Wood Balusters & Rosettes .....	32
Iron Balusters .....	33
Accessories .....	34-35



**CROOKED RIVER**  
BUILDING SUPPLY

# MOULDINGS

## CASING



PTN #	Species	Size
316	Primed FJ Pine	11/16" x 2-1/4" - 7'
316	Primed FJ Pine	11/16" x 2-1/4" - 14'



PTN #	Species	Size
N356	Primed MDF	19/32" x 2-1/4" - 7'
356	Primed MDF	19/32" x 2-1/4" - 14'
356	Primed FJ Pine	11/16" x 2-1/4" - 7'
356	Primed FJ Pine	11/16" x 2-1/4" - 14'



PTN #	Species	Size
L473	Primed MDF	19/32" x 2-1/4" - 15'



PTN #	Species	Size
351	Primed FJ Pine	11/16" x 2-1/2" - 16'
148A	Poplar	3/4" x 2-1/2"



PTN #	Species	Size
L471	Primed MDF	19/32" x 2-3/4" - 15'



PTN #	Species	Size
445A	Primed MDF	11/16" x 3-1/4" - 16'
0145	Poplar	3/4" x 3-1/4"

# MOULDINGS

## CASING



PTN #	Species	Size
683DB	Primed MDF	11/16" x 3-1/4" - 16'



PTN #	Species	Size
682DB	Primed MDF	1" x 3-1/4" - 16'



PTN #	Species	Size
412E2E	Primed MDF	19/32" x 3-1/2" - 16'



PTN #	Species	Size
444	Primed FJ PINE	11-16" x 3-1/2" - 16'
444A	Primed MDF	11/16" x 3-1/2" - 16'



PTN #	Species	Size
446	Primed MDF	11-16" x 3-1/2" - 16'



PTN #	Species	Size
RB3	Primed MDF	1" x 3-1/2" - 16'

# MOULDINGS

## CASING



PTN #	Species	Size
126-A	Poplar	3/4" x 3-1/2"



PTN #	Species	Size
9091M	Primed MDF	5/8" x 3-1/2" - 16'



PTN #	Species	Size
5010	Primed MDF	1-3/16" x 4-1/4" - 16'
183A	Poplar	1-3/16" x 4-1/4"

# MOULDINGS

## **BACK BAND**

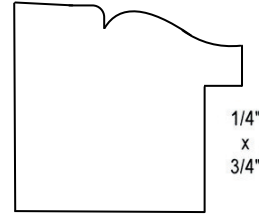
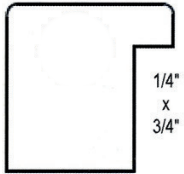

1-1/4" x 1-3/8"

PTN #	Species	Size
564	Poplar	1" x 1"

PTN #	Species	Size
563	Poplar	1-1/4" x 1-3/8" (1/4" x 3/4" DADO)

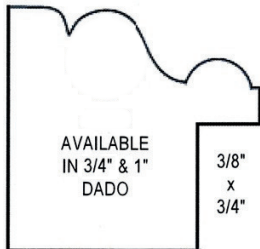

PTN #	Species	Size
510	Poplar	1-7/16" x 1-1/2" (3/8" x 3/4" DADO)
510	Poplar	1-11/16" x 1-1/2" (3/8" x 1" DADO)

# MOULDINGS

## BASE



PTN #	Species	Size
724	Primed FJ Pine	7/16" x 3" - 16'



PTN #	Species	Size
623	Primed FJ Pine	9/16" x 3-1/4" - 16'
623	Primed MDF	1/2" x 3-1/4" - 16'



PTN #	Species	Size
433E	Primed MDF	1/2" x 3-1/4" - 16'



PTN #	Species	Size
663	Primed FJ Pine	9/16" x 3-1/4" - 16'
663	Primed MDF	1/2" x 3-1/4" - 16'



PTN #	Species	Size
620	Primed MDF	1/2" x 4-1/4" - 16'



PTN #	Species	Size
4290	Primed MDF	1/2" x 5" - 16'

# MOULDINGS

## BASE



PTN #	Species	Size
163E	Primed FJ Pine	9/16" x 5-1/4" - 16'
163	Primed MDF	19/32" x 5-1/4" - 16'
0217	Poplar	9/16" x 5-1/4"
BASE	Rubber	9/16" x 5-1/4"



PTN #	Species	Size
LP813	Primed MDF	19/32" x 5-1/4" - 16'



PTN #	Species	Size
0210	Poplar	11/16" x 5-1/4"



PTN #	Species	Size
0209	Poplar	11/16" x 5-1/4"



PTN #	Species	Size
EE1E	Primed MDF	1/2" x 5-1/2" - 16'



PTN #	Species	Size
9291	Primed MDF	1/2" x 6-1/2" - 16'

# MOULDINGS

## BASE



PTN #	Species	Size
7163	Primed MDF	19-32" x 7-1/4" - 16'
0217	Poplar	9/16" x 7-1/4"



PTN #	Species	Size
EE1E	Primed MDF	1/2" x 7-1/4" - 16'

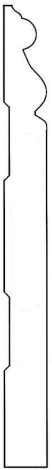

PTN #	Species	Size
0209	Poplar	11/16" x 7-1/4"

## BASE CAP



PTN #	Species	Size
1057-A	Poplar	9/16" x 1-3/4"



PTN #	Species	Size
209SIM	Poplar	11/16" x 2"

# MOULDINGS

## SHOE

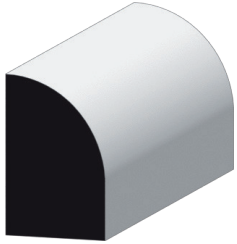

PTN #	Species	Size
126	Primed FJ Pine	1/2" x 3/4" - 16'
126	Rubber	1/2" x 3/4"

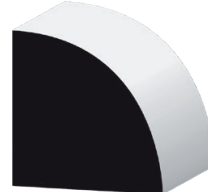

PTN #	Species	Size
105	Primed FJ Pine	3/4" x 3/4" - 16'

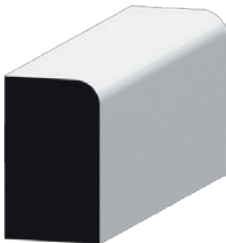

PTN #	Species	Size
128	Primed FJ Pine	7/16" x 3/4" - 16'
254	Rubber	7/16" x 3/4"

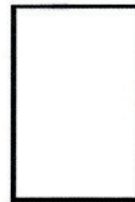

PTN #	Species	Size
S4S	Poplar	7/16" x 3/4"



PTN #	Species	Size
802	Poplar	1/2" x 3/4"
802	Red Oak	1/2" x 3/4"

# MOULDINGS

## CROWN

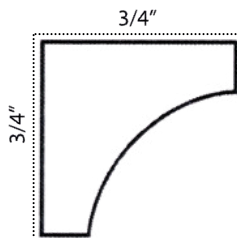

PTN #	Species	Size
402	Poplar	3/4" x 3/4"
438A	Poplar	5/8" x 5/8"

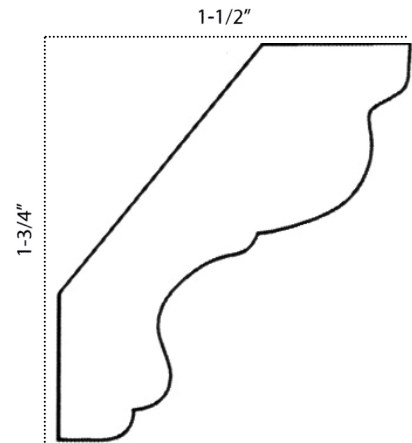

PTN #	Species	Size
418A	Poplar	11/16" x 2-1/4"

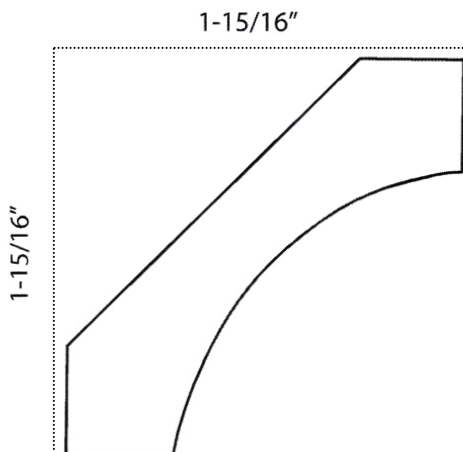

PTN #	Species	Size
406	Poplar	3/4 x 2-3/4"

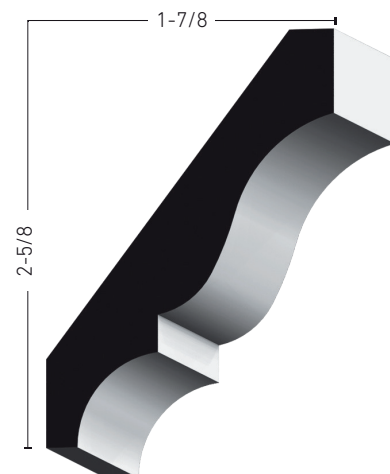

PTN #	Species	Size
L51	Primed FJ Pine	9/16" x 3-1/4" - 16'

# MOULDINGS

## CROWN

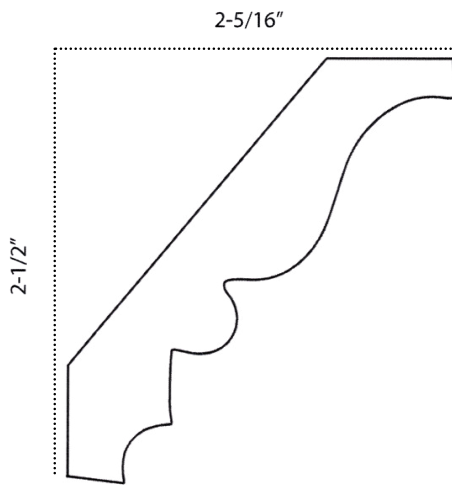

PTN #	Species	Size
419A	Poplar	11/16" x 3-3/8"

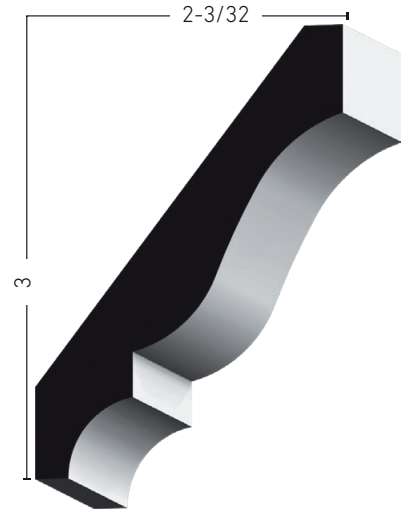

PTN #	Species	Size
L49	Primed MDF	19/32" x 3-5/8" - 16'

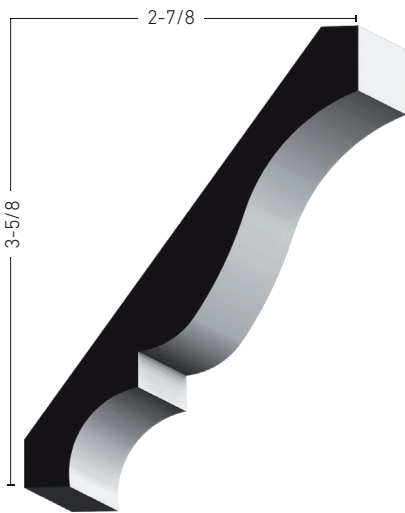

PTN #	Species	Size
L47	Primed MDF	19/32" x 4-5/8" - 16'

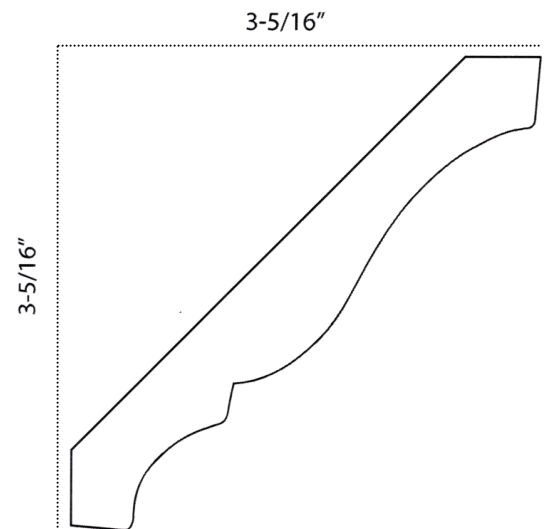

PTN #	Species	Size
421A	Poplar	11/16" x 4-5/8"

# MOULDINGS

## CROWN

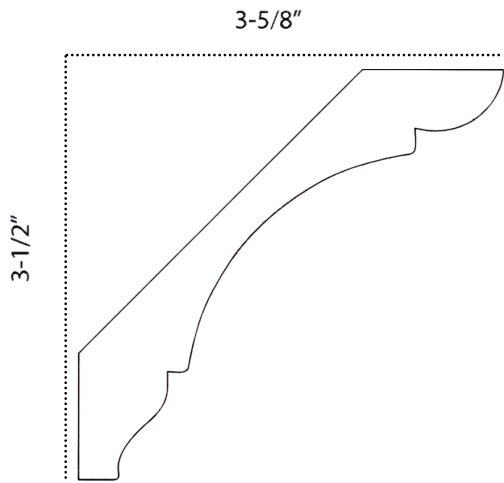

PTN #	Species	Size
422A	Poplar	1" x 5"

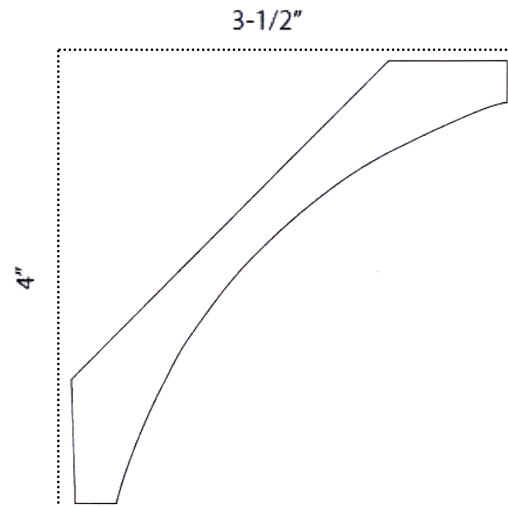

PTN #	Species	Size
443A	Poplar	1" x 5-1/4"

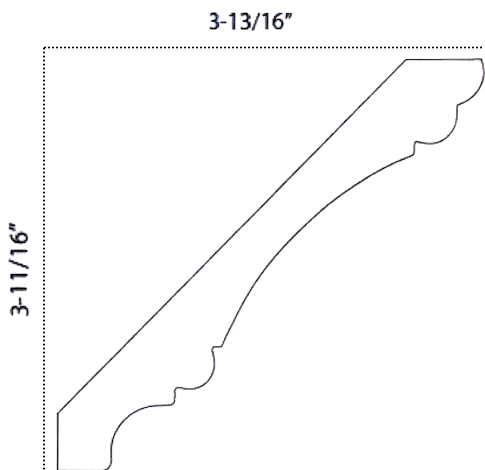

PTN #	Species	Size
469A	Poplar	3/4" x 5-1/4"



PTN #	Species	Size
423A	Poplar	3/4" x 5-1/4"

# MOULDINGS

## CROWN

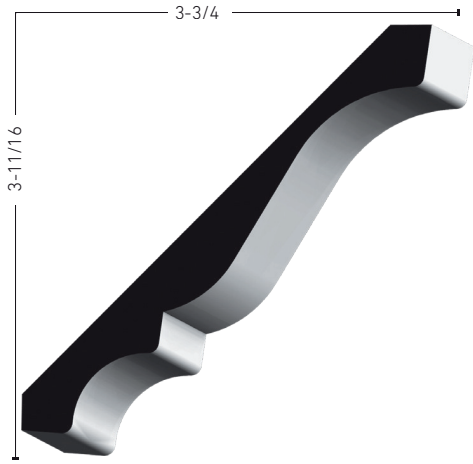

PTN #	Species	Size
L45	Primed MDF	19/32" x 5-1/4" - 16'

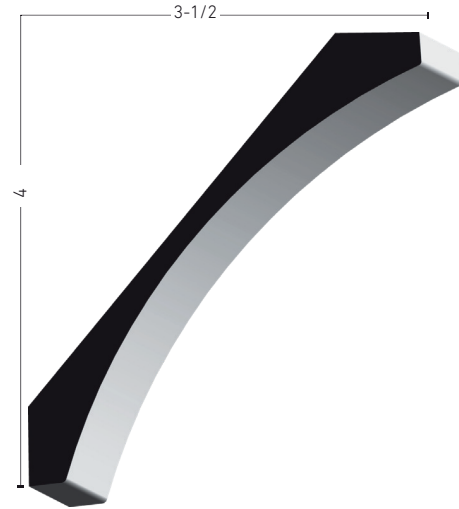

PTN #	Species	Size
CR291	Primed MDF	3/4" x 5-1/4" - 16'

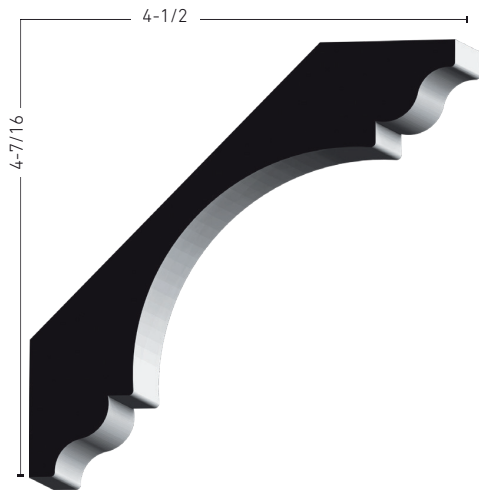

PTN #	Species	Size
041	Primed MDF	1-3/16" x 6-5/16" - 16'

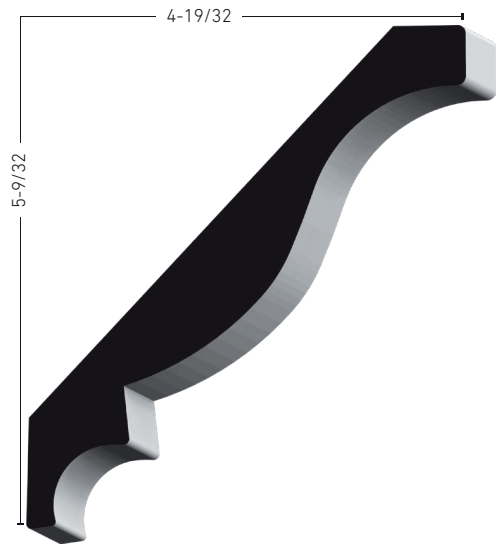

PTN #	Species	Size
043	Primed MDF	1" x 6-15/16" - 16'

# MOULDINGS

## CROWN

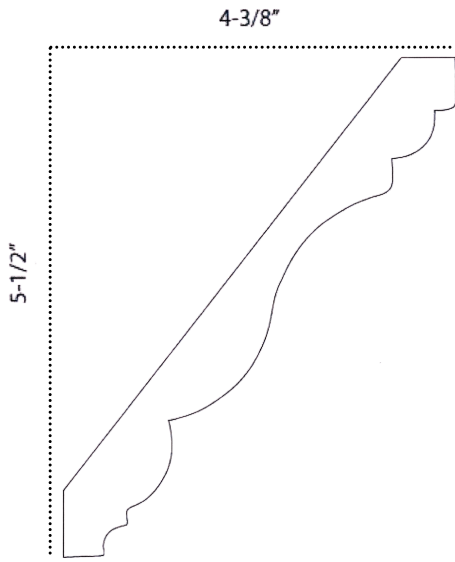

PTN #	Species	Size
465	Poplar	13/16" x 7"

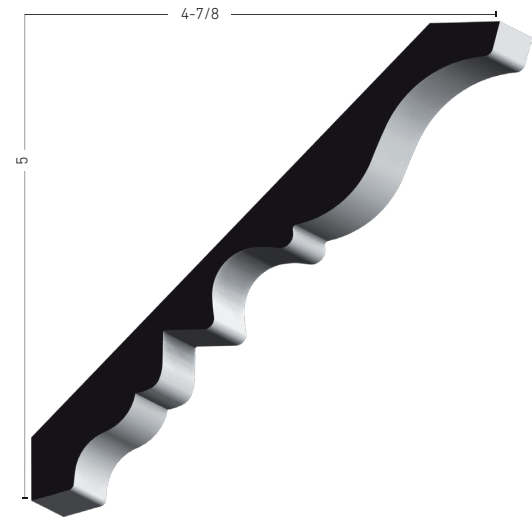

PTN #	Species	Size
42	Primed MDF	11/16" x 7" - 16'

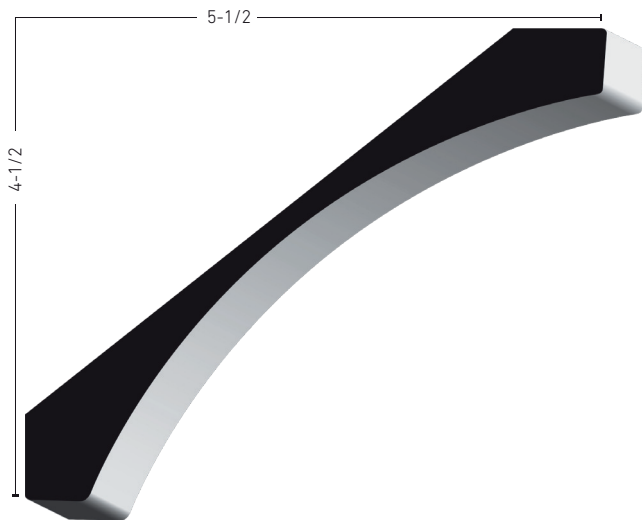

PTN #	Species	Size
505M	Primed MDF	1" x 7" - 16'

# MOULDINGS

## CHAIR RAIL

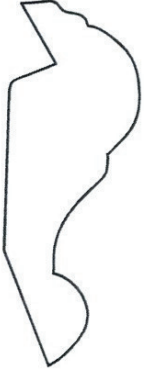

PTN #	Species	Size
625	Poplar	3/4" X 2"



PTN #	Species	Size
390	Primed FJ Pine	1 1/16" x 2-5/8" - 16'

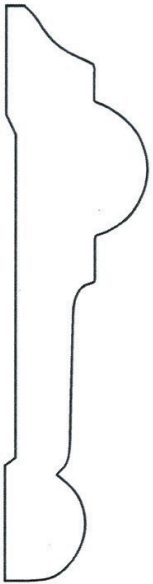

PTN #	Species	Size
605	Poplar	7/8" X 3-1/2"

# MOULDINGS

## PANEL



PTN #	Species	Size
827	Poplar	9/16" x 9/16"
CROWN	Rubber	5/8" x 9/16"



PTN #	Species	Size
1055A	Poplar	1/4" x 3/4"

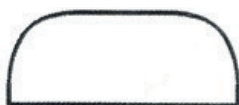

PTN #	Species	Size
1020	Poplar	5/16" x 3/4"



PTN #	Species	Size
1038A	Poplar	1/2" x 3/4"



PTN #	Species	Size
1037A	Poplar	1/2" x 1-1/8"

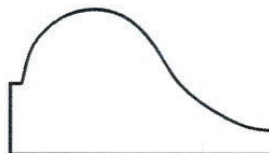

PTN #	Species	Size
1039A	Poplar	11/16" x 1-1/4"
PANEL/ BED	Rubber	5/8" x 1-1/4"

# MOULDINGS

## PANEL

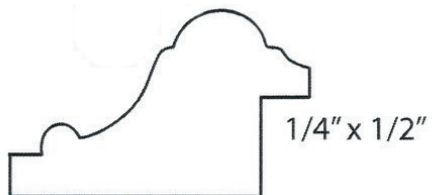

PTN #	Species	Size
555	Poplar	15/16" x 1-1/2"



PTN #	Species	Size
1019	Poplar	5/8" x 1-1/2"

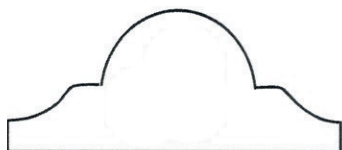

PTN #	Species	Size
1036A	Poplar	3/4" x 1-3/4"

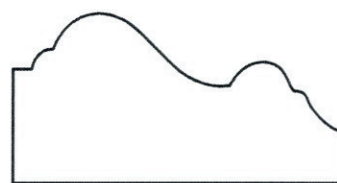

PTN #	Species	Size
1034A	Poplar	7/8" x 1-3/4"

# MOULDINGS

## MISCELLANEOUS

### DOOR STOPS



PTN #	Species	Size
936	Primed FJ Pine	7/16" x 1-3/8" - 7'
936	Primed FJ Pine	7/16" x 1-3/8" - 8' 2"
936	Primed FJ Pine	7/16" x 1-3/8" - 17'
1024	Poplar	3/8" x 1 1/4" - 7'
1024	Poplar	3/8" x 1 1/4" - 8' 2"



PTN #	Species	Size
876	Primed FJ Pine	7/16" x 1-3/8" - 7'
876	Primed FJ Pine	7/16" x 1-3/8" - 8' 2"
876	Primed FJ Pine	7/16" x 1-3/8" - 17'
1059A	Poplar	11/32" x 1-3/8" - 7'
1059A	Poplar	11/32" x 1-3/8" - 8' 2"

### PENCIL MOULD



PTN #	Species	Size
813	Poplar	3/4" x 3/4"

### NECK MOULD

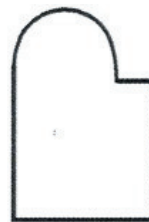

PTN #	Species	Size
803	Poplar	1/2" x 3/4"
803	Poplar	1/2" x 1-5/8"

### STRINGER MOULD



PTN #	Species	Size
STRINGER	Poplar	1/2" x 3/4"

### ASTRAGALS



PTN #	Species	Size
ASTRAGAL	Primed FJ Pine	1-1/4" x 2" - 8'
ASTRAGAL SQUARE	Primed FJ Pine	1-1/4" x 2" - 8'

# MOULDINGS

## MISCELLANEOUS

### WINDOW STOOL

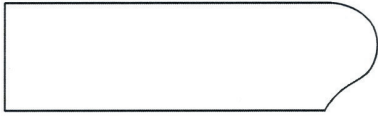

PTN #	Species	Size
902	Poplar	7/8" x 1-1/2"
902	Poplar	7/8" x 3"
902	Poplar	7/8" x 5-1/2"

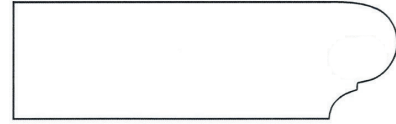

PTN #	Species	Size
903	Poplar	1-1/16" x 2-1/2"
903	Poplar	1-1/16" x 3-1/2"
903	Poplar	1-1/16" x 7-1/4"

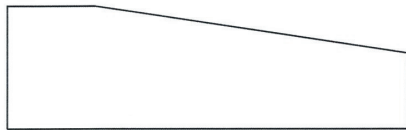

PTN #	Species	Size
PLINTH	Poplar	1-1/8" x 3-5/8"

### TONGUE & GROOVE/SIPLAP



PTN #	Species	Size
LSBW4	Primed MDF	19/32" (15MM) x 5-1/4" (5" FACE) - 16'



PTN #	Species	Size
1X6	MDF	11/16" x 5-1/4" (5" FACE) - 16'
1X8	MDF	11/16" x 7-1/4" (7" FACE) - 16'

# SHEET GOODS AND BOARDS

PTN #	Dimensions	Species	PTN #	Dimensions	Species	PTN #	Dimensions	Species/Type
Primed FJ Poplar Boards			Red Oak Boards			MDF Panels		
1X2	3/4" x 1-1/2"	Primed FJ	1X2	3/4" x 1-1/2"	Red Oak	1/4"	1/4" x 49" - 97"	MDF
1X4	3/4" x 3-1/2"	Primed FJ	1X2 Net	3/4" x 2"	Red Oak	1/2"	1/2" x 49" - 97"	MDF
1X6	3/4" x 5-1/2"	Primed FJ	1X3	3/4" x 2-1/2"	Red Oak	3/4"	3/4" x 49" - 97"	MDF
1X8	3/4" x 7-1/4"	Primed FJ	1X4	3/4" x 3-1/2"	Red Oak	White Melamine		
1X10	3/4" x 9-1/4"	Primed FJ	1X6	3/4" x 5-1/2"	Red Oak	1/4"	1/4" x 4' x 8'	White 1-Side
1X12	3/4" x 11-1/4"	Primed FJ	1X8	3/4" x 7-1/4"	Red Oak	3/4"	3/4" x 4' x 8'	White 2-Sides
5/4X6	1" x 5-1/2"	Primed FJ	1X10	3/4" x 9-1/4"	Red Oak	White Melamine Edge Band Shelving		
Lattice Boards			1X12	3/4" x 11-1/4"	Red Oak	3/4"	3/4" x 4' x 8'	White 2 Edges
1/4X2	1/4" x 1-3/4"	Poplar	Soft Maple Boards			3/4"	3/4" x 12" x 8'	White 1 Edge
1/4X3	1/4" x 2-1/2"	Poplar	1X2	3/4" x 1-1/2"	Soft Maple	3/4"	3/4" x 12" x 12'	White 1 Edge
1/4X4	1/4" x 3-1/2"	Poplar	1X3	3/4" x 2-1/2"	Soft Maple	3/4"	3/4" x 16" x 8'	White 1 Edge
1/4X5	1/4" x 4-1/2"	Poplar	1X4	3/4" x 3-1/2"	Soft Maple	3/4"	3/4" x 16" x 12'	White 1 Edge
1/4X6	1/4" x 5-1/2"	Poplar	1X6	3/4" x 5-1/2"	Soft Maple	3/4"	3/4" x 24" x 8'	White 2 Edges
1/4X8	1/4" x 7-1/4"	Poplar	1X8	3/4" x 7-1/4"	Soft Maple	3/4"	3/4" x 24" x 12'	White 1 Edge
1/4X10	1/4" x 9-1/4"	Poplar	White Oak Boards			White Edge Banding		
1X Poplar Boards			1X2	3/4" x 1-1/2"	White Oak	13/16"	25'	Peel & Stick/Pre-Glued
1X2	3/4" x 1-1/2"	Poplar	1X4	3/4" x 3-1/2"	White Oak	13/16"	50'	Peel & Stick
1X2 Net	3/4" x 2"	Poplar	1X6	3/4" x 5-1/2"	White Oak	13/16"	250'	Pre-Glued
1X3	3/4" x 2-1/2"	Poplar	1X8	3/4" x 7-1/2"	White Oak	Maple Plywood		
1X4	3/4" x 3-1/2"	Poplar	MDF Boards			1/4"	1/4" x 4' x 8'	Maple B4
1X6	3/4" x 5-1/2"	Poplar	1X4	(18mm) 11/16" x 3-1/2"	MDF	1/2"	1/2" x 4' x 8'	Maple B2
1X8	3/4" x 7-1/4"	Poplar	1X6	(18mm) 11/16" x 5-1/2"	MDF	3/4"	3/4" x 4' x 8'	Maple B2
1X10	3/4" x 9-1/4"	Poplar	1X8	(18mm) 11/16" x 7-1/4"	MDF	Maple Edge Banding		
1X12	3/4" x 11-1/4"	Poplar	1X10	(18mm) 11/16" x 9-1/4"	MDF	13/16"	25'	Peel & Stick/Pre-Glued
5/4X Poplar Boards			1X12	(18mm) 11/16" x 11-1/4"	MDF	13/16"	50'	Peel & Stick/Pre-Glued
5/4X4	1-1/16" x 3-1/2"	Poplar	5/4X6	(25mm) 1" x 5-1/2"	MDF	13/16"	250'	Pre-Glued
5/4X6	1-1/16" x 5-1/2"	Poplar	5/4X8	(25mm) 1" x 7-1/4"	MDF	Primed MDF Beaded Panel		
5/4X8	1-1/16" x 7-1/4"	Poplar	Rubber Boards			1/4"	1/4" x 4' x 8'	Beaded - 1-1/2" O.C.
5/4X10	1-1/16" x 9-1/4"	Poplar	1X4	3/4" x 3-1/2"	Rubber	HDF Plywood Core		
5/4X12	1-1/16" x 11-1/4"	Poplar	1X6	3/4" x 5-1/2"	Rubber	3/4"	3/4" x 4' x 8'	HDF
			1X8	3/4" x 7-1/4"	Rubber	3/4"	3/4" x 4' x 10'	HDF
						Red Oak Plywood		
						3/4"	3/4" x 4' x 8'	Red Oak B2
						White Oak Plywood		
						3/4"	3/4" x 4' x 8'	VC Plain Slice

# OUR IN-HOUSE DOOR SHOP

At Crooked River we are proud of our in-house door shop. Our door shop gives us the capability to supply our customers with custom, reliable, stock door products. We take raw door slabs and turn them into fully prepped, ready-to-install units. We custom mortise for hinges, drill for handles, strikes, and fabricate our own jambs to suit your exact project requirements. That means when your door leaves our shop, it's ready and fit to be installed.

Since our interior doors are machined on-site, you have more control over sizing, hardware prep, and custom jamb details—all at a better price. Whether you need a standard size door or something unique, we tailor each door to your needs. Our in-house stock door slab options are shown in this catalog on pages 22-28.



## NON-STOCK BRAND HIGHLIGHT:

**TRUStILE**  
A MARVIN BRAND

Need **custom interior doors** that fit your project perfectly? Consider TruStile.

## Any Door, Any Style, Any Size:

TruStile has developed a manufacturing capability that allows them to provide literally any door style for any sized opening. Every door is built to order, providing customers the flexibility to specify the exact style and size required for each and every door opening. TruStile believes doors are a critical design element in today's home. TruStile supports this vision by offering the broadest product line and the highest quality product in the door industry. With more than 400 styles or any custom design available in paintable MDF (medium density fiberboard) or any stain-grade wood, TruStile can fulfill any design requirement. All TruStile doors feature architecturally correct stile and rail construction, the highest quality materials and are backed by a lifetime warranty.



[www.trustile.com](http://www.trustile.com)

# STOCK DOORS

## HARDBOARD FLUSH SMOOTH DOORS - 1-3/8"

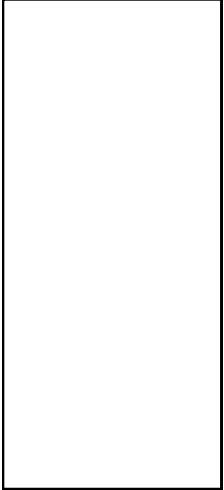

Width	Height	Sticking	Core
1/6	6/8	None	Solid
2/0	6/8	None	Solid
2/4	6/8	None	Solid
2/6	6/8	None	Solid
2/8	6/8	None	Solid
3/0	6/8	None	Solid

## PRIMED HARDBOARD - SMOOTH - RAISED PANEL - 1-3/8"

### 2-PANEL SQUARE - CARRARA

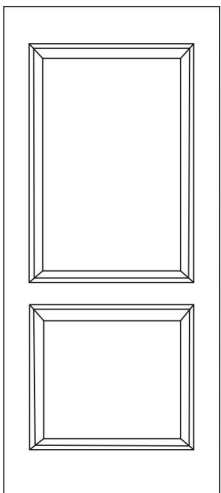

Width	Height	Sticking	Core
1/6	6/8	Cove & Bead	Solid OR Hollow
	8/0	Cove & Bead	Solid
2/0	6/8	Cove & Bead	Solid OR Hollow
	8/0	Cove & Bead	Solid
2/4	6/8	Cove & Bead	Solid OR Hollow
	8/0	Cove & Bead	Solid
2/6	6/8	Cove & Bead	Solid OR Hollow
	8/0	Cove & Bead	Solid
2/8	6/8	Cove & Bead	Solid OR Hollow
	8/0	Cove & Bead	Solid
3/0	6/8	Cove & Bead	Solid OR Hollow
	8/0	Cove & Bead	Solid

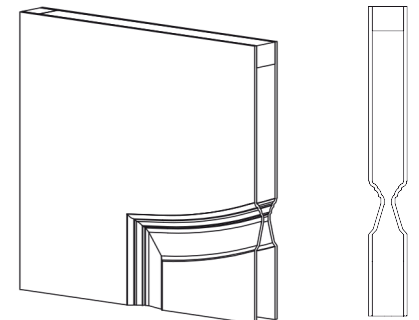

**Cove & Bead Sticking**

# STOCK DOORS

## PRIMED HARDBOARD - SMOOTH - RAISED PANEL - 1-3/8"

### 2-PANEL ROMAN ARCH - CAIMAN

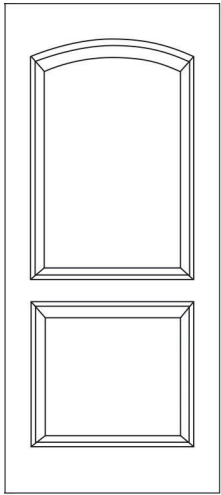

Width	Height	Sticking	Core
1/6	6/8	Cove & Bead	Solid OR Hollow
	8/0	Cove & Bead	Solid
2/0	6/8	Cove & Bead	Solid OR Hollow
	8/0	Cove & Bead	Solid
2/4	6/8	Cove & Bead	Solid OR Hollow
	8/0	Cove & Bead	Solid
2/6	6/8	Cove & Bead	Solid OR Hollow
	8/0	Cove & Bead	Solid
2/8	6/8	Cove & Bead	Solid OR Hollow
	8/0	Cove & Bead	Solid
3/0	6/8	Cove & Bead	Solid OR Hollow
	8/0	Cove & Bead	Solid

Cove & Bead Sticking

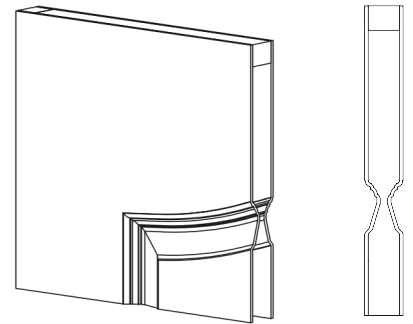

### 6-PANEL - COLONIST

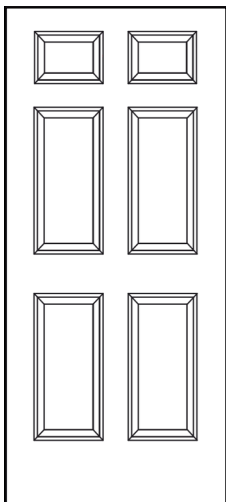

Width	Height	Sticking	Core
1/6	6/8	Cove & Bead	Solid
2/0	6/8	Cove & Bead	Solid
2/4	6/8	Cove & Bead	Solid
2/6	6/8	Cove & Bead	Solid
2/8	6/8	Cove & Bead	Solid
3/0	6/8	Cove & Bead	Solid

Cove & Bead Sticking

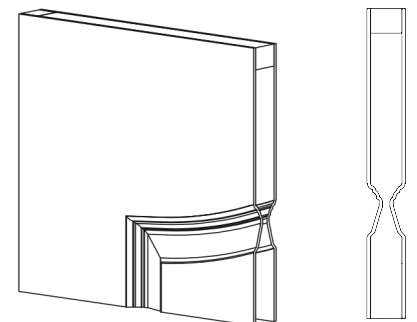

# STOCK DOORS

## STILE AND RAIL PRIMED WOOD/MDF- FLAT PANEL - 1-3/8"

### 1TM

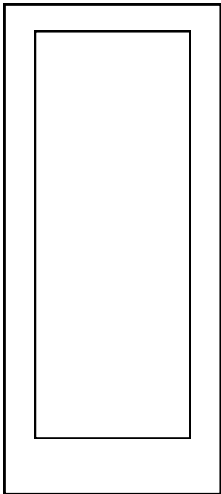

Width	Height	Sticking	Core
1/6	6/8	Square	Solid
	8/0	Square	Solid
2/0	6/8	Square	Solid
	8/0	Square	Solid
2/4	6/8	Square	Solid
	8/0	Square	Solid
2/6	6/8	Square	Solid
	8/0	Square	Solid
2/8	6/8	Square	Solid
	8/0	Square	Solid
3/0	6/8	Square	Solid
	8/0	Square	Solid

Square Sticking

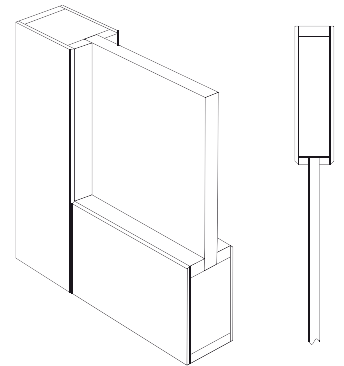

### 2TM

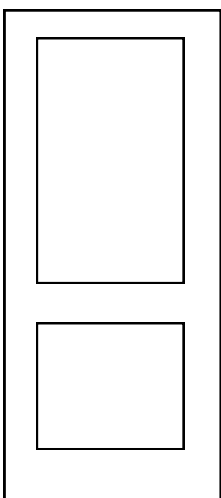

Width	Height	Sticking	Core
1/6	6/8	Square	Solid
	8/0	Square	Solid
2/0	6/8	Square	Solid
	8/0	Square	Solid
2/4	6/8	Square	Solid
	8/0	Square	Solid
2/6	6/8	Square	Solid
	8/0	Square	Solid
2/8	6/8	Square	Solid
	8/0	Square	Solid
3/0	6/8	Square	Solid
	8/0	Square	Solid

Square Sticking

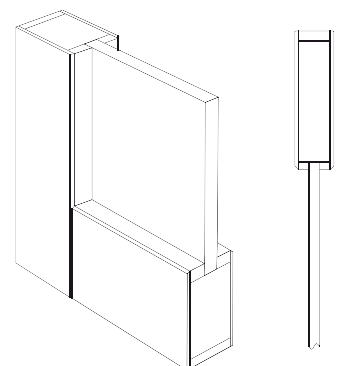

# STOCK DOORS

## STILE AND RAIL PRIMED WOOD/MDF-FLAT PANEL - 1-3/8"

3 CM

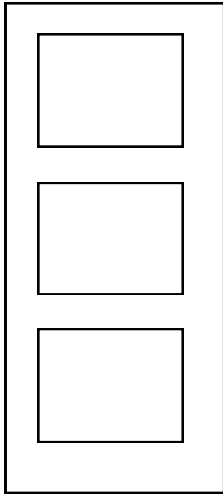

Width	Height	Sticking	Core
1/6	6/8	Square	Solid
	8/0	Square	Solid
2/0	6/8	Square	Solid
	8/0	Square	Solid
2/4	6/8	Square	Solid
	8/0	Square	Solid
2/6	6/8	Square	Solid
	8/0	Square	Solid
2/8	6/8	Square	Solid
	8/0	Square	Solid
3/0	6/8	Square	Solid
	8/0	Square	Solid

Square Sticking

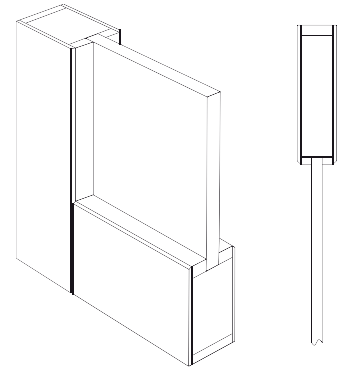

# STOCK DOORS

## PRIMED HARDBOARD - MOULDED FLAT PANEL - 1-3/8"

### MADISON

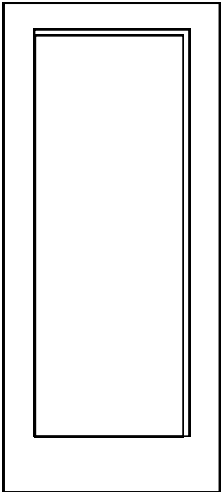

Width	Height	Sticking	Core
1/6	6/8	Craftsman Bevel	Solid
	8/0	Craftsman Bevel	Solid
2/0	6/8	Craftsman Bevel	Solid
	8/0	Craftsman Bevel	Solid
2/4	6/8	Craftsman Bevel	Solid
	8/0	Craftsman Bevel	Solid
2/6	6/8	Craftsman Bevel	Solid
	8/0	Craftsman Bevel	Solid
2/8	6/8	Craftsman Bevel	Solid
	8/0	Craftsman Bevel	Solid
3/0	6/8	Craftsman Bevel	Solid
	8/0	Craftsman Bevel	Solid

Craftsman Bevel Sticking

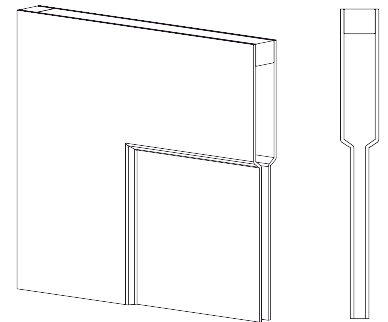

### MONROE

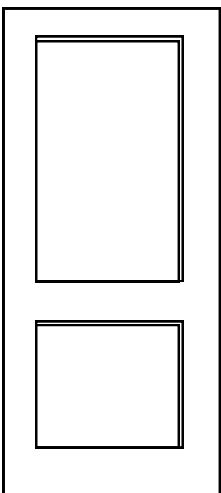

Width	Height	Sticking	Core
1/6	6/8	Craftsman Bevel	Solid
	8/0	Craftsman Bevel	Solid
2/0	6/8	Craftsman Bevel	Solid
	8/0	Craftsman Bevel	Solid
2/4	6/8	Craftsman Bevel	Solid
	8/0	Craftsman Bevel	Solid
2/6	6/8	Craftsman Bevel	Solid
	8/0	Craftsman Bevel	Solid
2/8	6/8	Craftsman Bevel	Solid
	8/0	Craftsman Bevel	Solid
3/0	6/8	Craftsman Bevel	Solid
	8/0	Craftsman Bevel	Solid

Craftsman Bevel Sticking

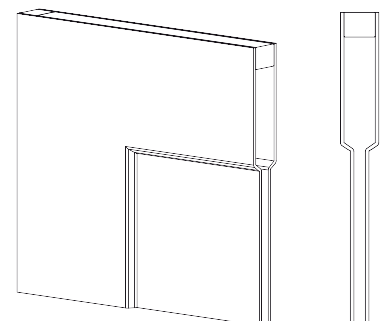

# STOCK DOORS

## PRIMED HARDBOARD - MOULDED FLAT PANEL - 1-3/8"

### CRAFTSMAN III

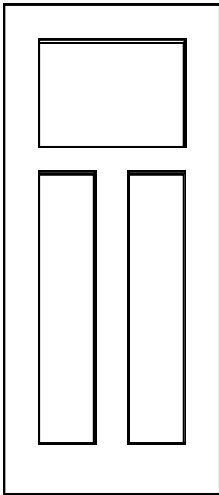

Width	Height	Sticking	Core
1/6	6/8	Craftsman Bevel	Solid
2/0	6/8	Craftsman Bevel	Solid
2/4	6/8	Craftsman Bevel	Solid
2/6	6/8	Craftsman Bevel	Solid
2/8	6/8	Craftsman Bevel	Solid
3/0	6/8	Craftsman Bevel	Solid

#### Craftsman Bevel Sticking

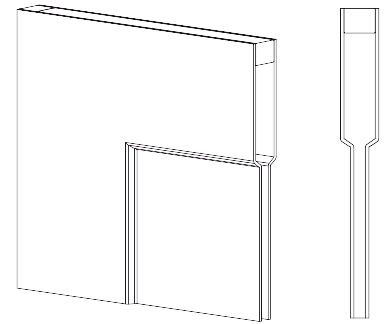

## PRIMED WOOD/MDF GLASS DOORS - 1-3/8"

### 1-LITE



Width	Height	Sticking	Glass
2/0	6/8	Square	Clear
	8/0	Square	Clear
2/6	6/8	Square	Clear
	8/0	Square	Clear

#### Square Sticking

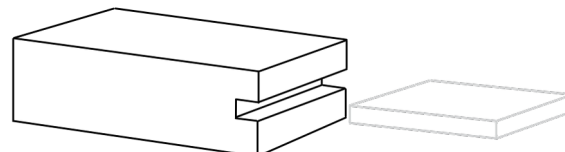

# STOCK DOORS

## PRIMED WOOD/MDF GLASS DOORS - 1-3/8"

### 10-LITE

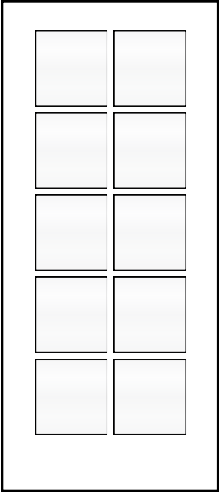

Width	Height	Sticking	Glass
2/6	6/8	Ovolo	Clear

Ovolo Sticking

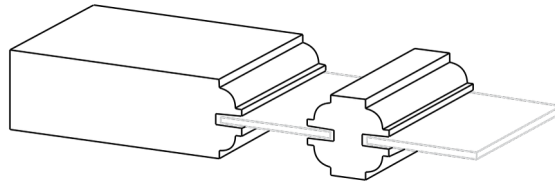

### 12-LITE

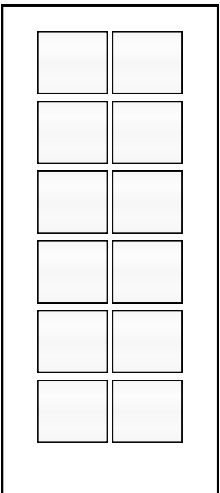

Width	Height	Sticking	Glass
2/6	8/0	Ovolo	Clear

Ovolo Sticking

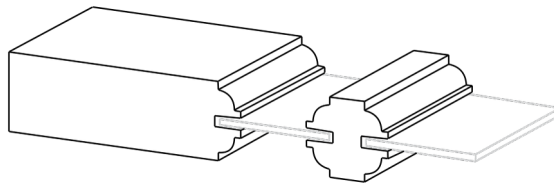

# STAIR PARTS

## RAILING

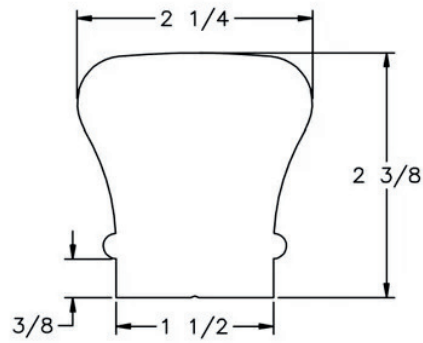

PTN #	Species	Size
6010	Poplar	2-3/8" x 2-5/16"

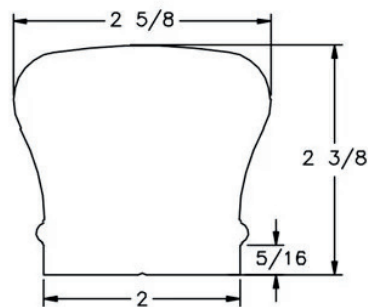

PTN #	Species	Size
6210	Poplar	2-3/8" x 2-5/8"
6210	White Oak	2-3/8" x 2-5/8"

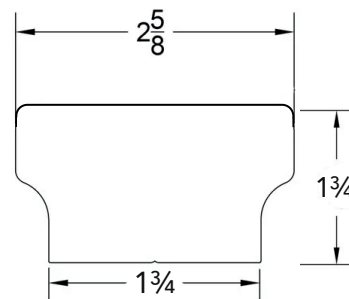

PTN #	Species	Size
6084	Poplar	2-9/16" x 1-3/4"
6084	Red Oak	2-9/16" x 1-3/4"
6084	White Oak	2-9/16" x 1-3/4"

# STAIR PARTS

## RAILING

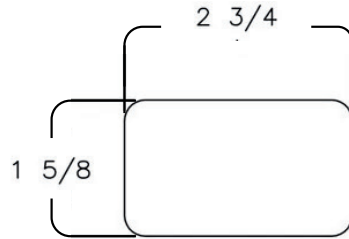

PTN #	Species	Size
6002	Poplar	2-5/8" x 1-9/16"
6002	White Oak	2-5/8" x 1-9/16"

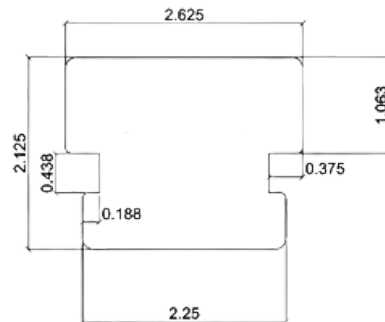

PTN #	Species	Size
7800	Poplar	2-5/8" x 2-1/8" With 7/16" Notch
7800	White Oak	2-5/8" x 2-1/8" With 7/16" Notch

# STAIR PARTS

## NEWEL POSTS



PTN #	Species	Size
4375	Poplar	4-3/4" x 62"



PTN #	Species	Size
4091	Poplar	6-1/4" x 55"



PTN #	Species	Size
4002-48	Poplar	3-1/2" x 48"
4002-48	Red Oak	3-1/2" x 48"
4002-48	White Oak	3-1/2" x 48"
4002-48Half	Poplar	1-3/4" x 48"
4002-48Half	White Oak	1-3/4" x 48"

# STAIR PARTS

## WOOD BALUSTERS & ROSETTES



PTN #	Species	Size
5060	Poplar	1-1/4" x 42"



PTN #	Species	Size
5360	Poplar	1-3/4" x 42"
5360	White Oak	1-3/4" x 42"

## ROSETTES



PTN #	Species	Size
4X6	Poplar	4-5/16" X 6"
4X6	White Oak	4-5/16" X 6"



PTN #	Species	Size
4X6	Poplar	4-1/2" x 6-1/2"
4X6	Red Oak	4-1/2" x 6-1/2"
4X6	White Oak	4-1/2" x 6-1/2"

# STAIR PARTS

## IRON BALUSTERS

### LOW SHEEN BLACK FINISH



PTN #	Species	Size
PLA44	Iron	1/2" X 44" Hollow Square



PTN #	Species	Size
1TW44	Iron	1/2" x 44" Hollow Square



PTN #	Species	Size
65144	Iron	5/8" X 44" Hollow Round
TUBE-58LSB	Horizontal Iron	5/8" X 96" Hollow Round

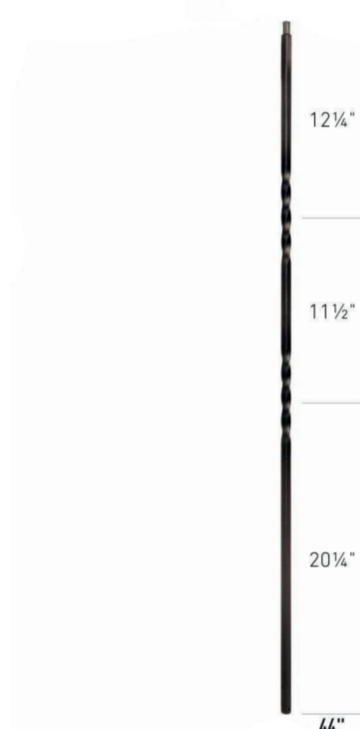

PTN #	Species	Size
2TW44	Iron	1/2" x 44" Hollow Square

# STAIR PARTS

## ACCESSORIES



**PS02**  
Baluster  
Low Sheen Black  
Rake Shoe



**M06**  
Baluster  
Low Sheen Black  
Flat Shoe



**AK01**  
Low Sheen Black  
Knuckle



**CNCL 12**  
Concealed Fastener  
For 1/2" Balusters  
(Level and Kneewall  
Applications)



**Tapered Wood Plug**

PTN #	Species	Size
3000	Poplar	1"
3000	Red Oak	1"
3000	White Oak	1"

PTN #	Species	Size
3024	Poplar	1/2"
3024	Red Oak	1/2"
3024	White Oak	1/2"



**7002**  
Pin-EZ

# STAIR PARTS ACCESSORIES

Patent US11828068



**3005**  
KEYLOCK™  
NEWEL  
MOUNTING  
FASTENER

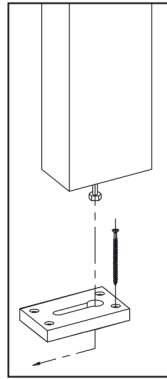

**3076**  
BALUSTER DOWEL  
FAST SCREWS

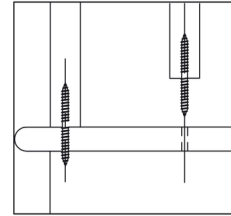

**3008-10**  
NEWELPOST  
FASTENER  
10-3/4"

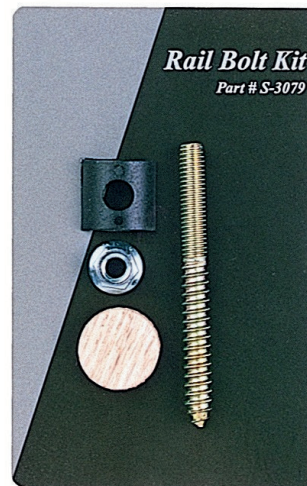
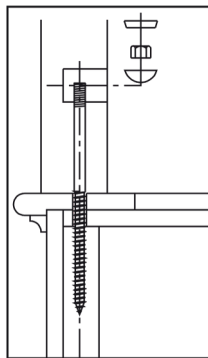

**3001 /  
3079**  
RAIL BOLT

# NOTES

**MARVIN** 

 **HOLMES**  
STAIR PARTS

**THERMA TRU**  
DOORS

 **L.J. Smith**  
stair systems

**TRŪSTILE**  
A MARVIN  BRAND

**DuxxBak**

 **HARVEY**  
WINDOWS + DOORS

 **SURE SILL**  
BUILDING CONFIDENCE

 **ProVia**  
THE PROFESSIONAL WAY

*Atlantic*  
Premium Shutters®

**VELUX**®

 **Tyvek**

 **DSA**  
Master Crafted Doors

 **NOVO**  
Building Products

**BALDWIN**

 **LP**  
BUILDING SOLUTIONS

**SCHLAGE**®

 **RESINART**

**EMTEK**

 **OSI**  
TOUGHER THAN THE ELEMENTS

 **BHP**  
**BETTER HOME PRODUCTS**

 **Good's**  
MILLWORK



# **CROOKED RIVER**

## **BUILDING SUPPLY**