

TRUSTILE[®]
A MARVIN BRAND

TRUSTILE WOOD ENTRY SYSTEMS
DESIGN THAT MOVES YOU





See page 30 for product details.

THE TRUSTILE STORY

Since 1995, TruStile has put design at the center of our products and processes. From the materials we select to our exacting craft and design, we engineer for quality that sets the tone for the whole home. In collaboration with our parent company, Marvin®, we have created a family of premium entry systems that don't just transform a space, but how you feel inside it. Make the entry to your new home a most welcoming invitation with an exceptional entrance by TruStile.

EXCELLENCE
IN ENTRY
SYSTEMS

TRŪSTILE®
A MARVIN® BRAND

MARVIN® 



TRUSTILE RESERVE

System Code	TMF1000-103B
Layout	ES103
Door Style	TMF1000
Sidelite	DSG100
Wood Species	Mahogany
Finish	Ebony
Glass	White Lami



TABLE OF CONTENTS

Wood Entry Systems	4
Entry System Selection Guide.....	6
Architectural Styles Overview.....	8
Modern	10
Traditional.....	22
Modern Farmhouse	30
French Country	36
Coastal	42
Mediterranean.....	48
Craftsman	54
Cape Cod.....	60
Entry System Layouts	66
Door Style Reference Guide	68
Outswing Doors	83
Transom and Sidelite Options.....	84
Construction and Acetylation.....	86
Profile Options and Mull Construction.....	88
Wood Species and Stain Options.....	90
Hinge, Sill, Glass and Multipoint Lock Options	92
Entry System Comparison	94
Warranty and Overhang Requirements.....	95
Design Tools.....	96

TRUSTILE ENTRY SYSTEMS MATERIAL CONSTRUCTION



Resilient Wood Entry Systems™

The Resilient Wood Entry System sets the tone of quality for the whole home using the most durable painted construction without sacrificing any design options.

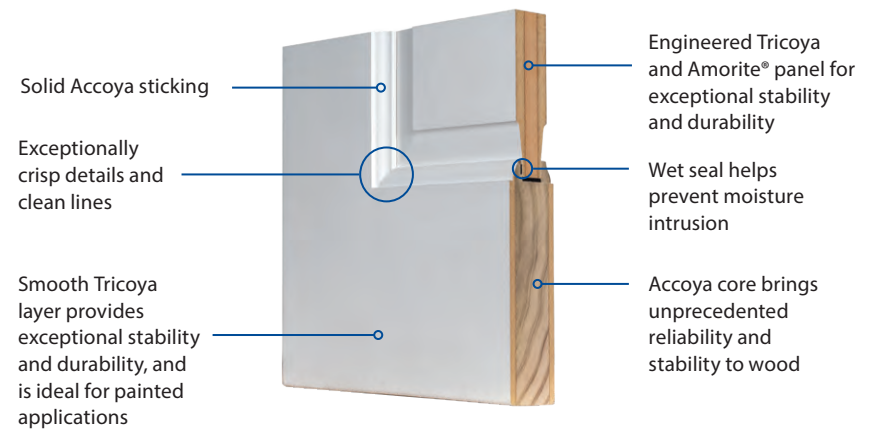

- Engineered with resilient Accoya®, an acetylated wood product, which brings unprecedented reliability and durability to wood.
- Tricoya® top layers provide exceptional stability, durability and paintability, for outdoor applications.
- Most configurations delivered pre-hung with an Accoya built jamb and a premium prime finish, ready to paint to match your design.
- 10-year warranty with limited and no-overhang applications, depending on system design specifications, for both inswing and outswing units.

Choose the Material Best Suited for Your Project

Both material construction options have been extensively tested and proven in partnership with the Marvin® Research and Development team.



Reserve Wood Entry Systems™

The Reserve Wood Entry System elevates the refined elegance of your home with the beauty of stained natural wood.

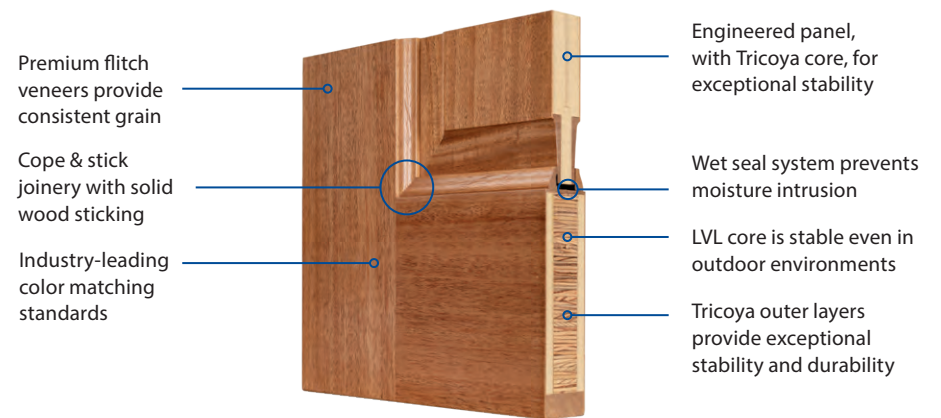

- Engineered with a laminated veneer lumber (LVL) core and Tricoya® layers to provide exceptional stability and durability.
- 10 natural wood species available with an extensive collection of premium factory stain options.
- Premium appearance standards ensure industry-leading grain and color matching.
- 5-year limited warranty with industry standard overhang requirements for both inswing and outswing units.

TRUSTILE ENTRY SYSTEMS

TWO WAYS TO CREATE YOUR ENTRY SYSTEM



Start designing at
www.trustile.com/configurator
Details on page 96.

Select From Our Featured Entry Systems

We've created over 80 featured entry systems that capture the current trends of popular architectural styles. Start with the style most closely matching your vision for your home and tailor it to match your tastes and requirements.

Or Build Your Own Entry System

Design your custom entry system in a few simple steps. Choose the right material for your project. Select from over 500 door styles and endless design options. Then finalize the details to your exact specifications.

Select From Over 80 Featured Entry Systems

See all options in each architectural section starting on page 9.

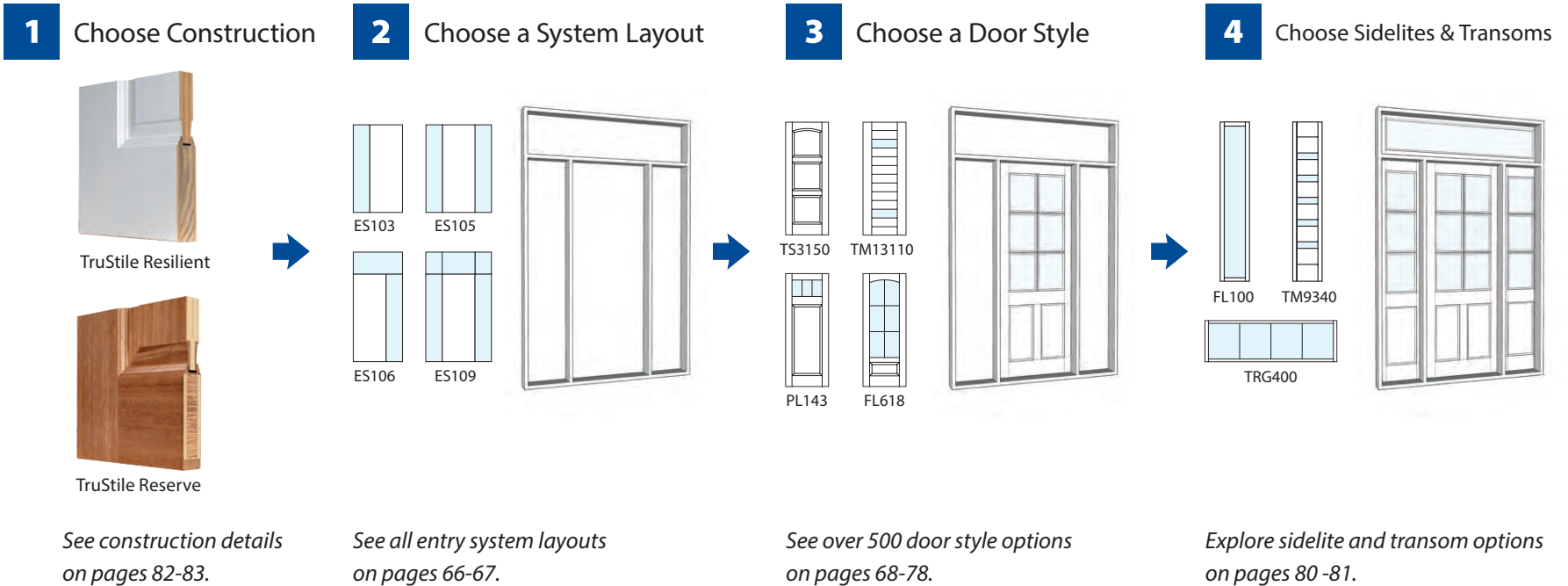



MODERN



TRADITIONAL



MODERN FARMHOUSE



COASTAL*



MEDITERRANEAN



CRAFTSMAN

** Architectural category only. Impact and hurricane ratings not currently available. See your TruStile dealer to verify compatibility with your local building code.*



SE



FRENCH COUNTRY



CAPE COD

Wood is a natural product and the finish and color will vary depending on the wood species and lighting on the job site. The images printed within this catalog are a representation of TruStile species and stain colors and do not replace seeing the stain and wood samples in person. Please visit your local TruStile dealer to request a factory finished stain sample.

ARCHITECTURAL STYLES

IMPACTFUL
SOPHISTICATED
AUTHENTIC

TruStile has curated over 80 featured designs across eight architectural styles to make it easy to find the right look for your new entrance.





MODERN

SLEEK

CONTEMPORARY

STRIKING

TRUSTILE RESERVE

System Code	TMIR6001-102B
Layout	ES102
Door Style	TMIR6001
Sidelite	DSG100
Profile	¼" Kerf Cut Reveal
Wood Species	Mahogany
Finish	White Haze
Glass	Clear

MODERN

TRUSTILE RESILIENT

System Code	TM3100-111B
Layout	ES111
Door Style	TM3100
Sidelite	DSG100
Transom	DSG100
Profile	SS Sticking
Wood Species	Resilient Wood
Finish	SW 7069 Iron Ore
Glass	Clear



TRUSTILE RESERVE

System Code	TMIR9001-108A
Layout	ES108
Door Style	TMIR9001
Sidelite	FL100
Transom	TRG100
Profile	1/4" Kerf Cut Reveal
Wood Species	Mahogany
Finish	Slate
Glass	Clear

Shown with reversed configuration and right handing.

MODERN

TRUSTILE RESERVE

System Code	TM9340-105C
Layout	ES105
Door Style	TM9340
Sidelite	TM9340
Profile	1/4" Kerf Cut Reveal
Wood Species	Rift Sawn White Oak
Finish	Grey Mist
Glass	White Lami

MODERN



TRUSTILE RESERVE

System Code	TMIR1002-102B
Layout	ES102
Door Style	TMIR1002
Sidelite	DSG100
Profile	1/4" Kerf Cut Reveal
Wood Species	Walnut
Finish	Ebony
Glass	Clear

MODERN

TRUSTILE RESERVE

System Code	TM6100-105A
Layout	ES105
Door Style	TM6100
Sidelite	TM1000
Profile	SS Sticking
Wood Species	Rift Sawn White Oak
Finish	White Haze
Glass	Clear

MODERN

TRUSTILE RESERVE

System Code	TMIR6000-106B
Layout	ES106
Door Style	TMIR6000
Sidelite	DSG100
Transom	DSG100
Profile	1/4" Kerf Cut Reveal
Wood Species	Mahogany
Finish	Cinnamon
Glass	Clear

MODERN

TRUSTILE RESILIENT

System Code	TMIR4000-108A
Layout	ES108
Door Style	TMIR4000
Sidelite	FL100
Transom	FL100
Profile	1/4" Kerf Cut Reveal
Wood Species	Resilient Wood
Finish	SW 2735 Rockweed
Glass	Clear



TRUSTILE RESERVE

System Code	TMF1000-103A
Layout	ES103
Door Style	TMF1000
Sidelite	FL100
Wood Species	Plain Sawn White Oak
Finish	Nutmeg
Glass	Clear

MODERN

TRUSTILE RESERVE

System Code	TM9350-105A
Layout	ES105
Door Style	TM9350
Sidelite	FL100
Profile	1/4" Kerf Cut Reveal
Wood Species	Walnut
Finish	Ebony
Glass	Clear

Choose One of Our Featured Entry Systems

Designed by TruStile and ready to order through your local dealer.

Featured Modern Entry Systems in this Catalog

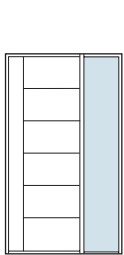

TMIR6001-102B
pg 10

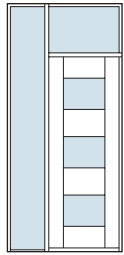

TM3100-111B
pg 12

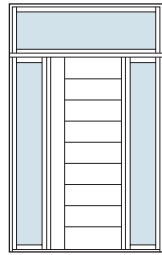

TMIR9001-108A
pg 13

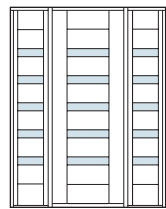

TM9340-105C
pg 14

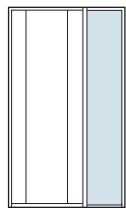

TMIR1002-102B
pg 15

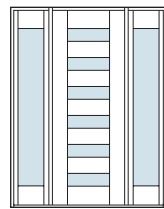

TM6100-105A
pg 16

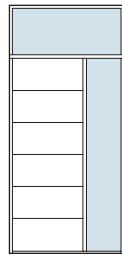

TMIR6000-106B
pg 17

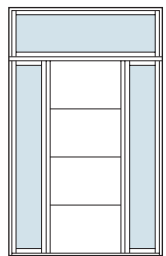

TMIR4000-108A
pg 18

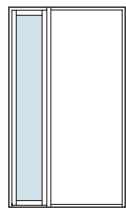

TMF1000-103A
pg 19

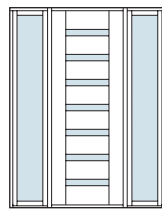

TM9350-105A
pg 20

Other Featured Modern Entry Systems

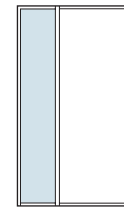

TMF1000-103B
pg 2

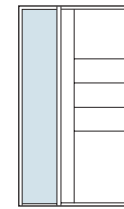

TMIR5101-103B
pg 68

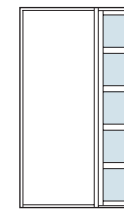

TMF1000-102D
online

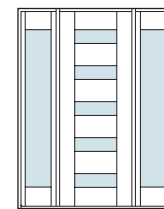

TM5100-105A
online

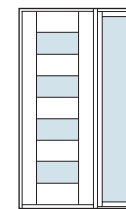

TM9160-102A
online

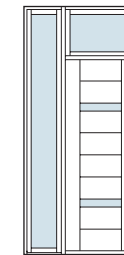

TM9310-111A
online

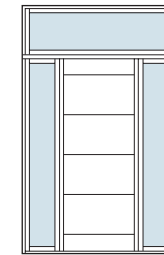

TMIR6080-108A
online

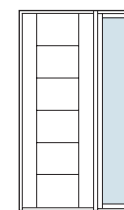

TM6001-ES102A
online

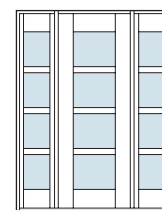

TM4000-105C
online

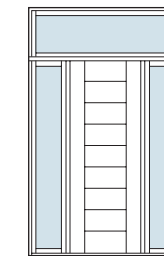

TM9000-108A
online

See more door style options on pages 68-75.





TRADITIONAL

CLASSIC

POLISHED

TIMELESS

TRUSTILE RESILIENT

System Code	TS3070-204A
Layout	ES204
Door Style	TS3070
Transom	FL100
Profile	QB Sticking/B Panel
Wood Species	Resilient Wood
Finish	SW 7069 Iron Ore
Glass	Clear

TRADITIONAL

TRUSTILE RESERVE

System Code	TS3000-109D
Layout	ES109
Door Style	TS3000
Sidelite	FL300
Transom	TRG100
Profile	QB Sticking/B Panel
Wood Species	Mahogany
Finish	Nutmeg
Glass	Clear



TRADITIONAL

TRUSTILE RESERVE

System Code	FL616-109C
Layout	ES109
Door Style	FL616
Sidelite	FL310
Transoms	TRG100 and TRG200
Profile	SS Sticking/C Panel
Wood Species	Plain Sawn White Oak
Finish	Hazelnut
Glass	Clear

TRADITIONAL

TRUSTILE RESERVE

System Code	TS6020-108D
Layout	ES108
Door Style	TS6020
Sidelite	TS3070
Transom	TRG600
Profile	OG Sticking/D Panel
Wood Species	Mahogany
Finish	Ebony
Glass	Clear

TRADITIONAL

TRUSTILE RESILIENT

System Code	TS3100-109C
Layout	ES109
Door Style	TS3100
Sidelite	FL110
Transom	TRG100
Profile	OS Sticking/A Panel
Wood Species	Resilient Wood
Finish	SW 6990 Caviar
Glass	Clear

TRADITIONAL

TRUSTILE RESERVE

System Code	TS4060-504A
Layout	ES504
Door Style	TS4060
Transom	TRG110
Profile	CB Sticking/B Panel
Wood Species	Mahogany
Finish	Cinnamon
Glass	Clear

Choose One of Our Featured Entry Systems

Designed by TruStile and ready to order through your local dealer.

Featured Traditional Entry Systems in this Catalog

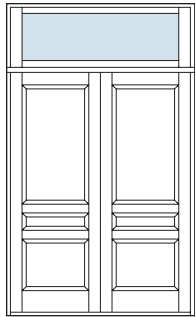

TS3070-204A
pg 22

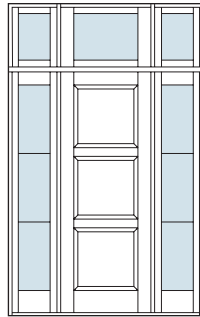

TS3000-109D
pg 24

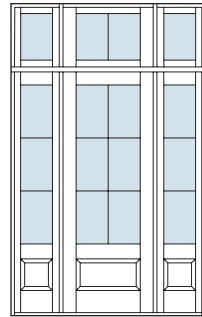

FL616-109C
pg 25

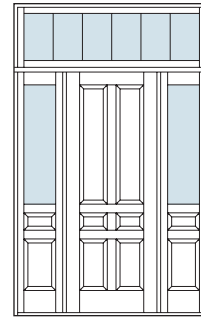

TS6020-108D
pg 26

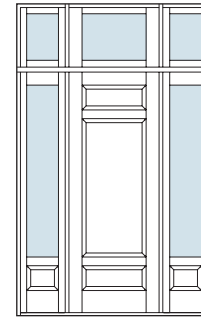

TS3100-109C
pg 27

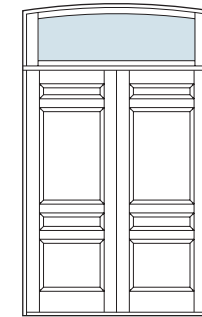

TS4060-504A
pg 28

Other Featured Traditional Entry Systems

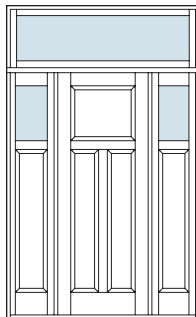

TS3300-108C
online

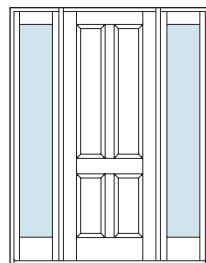

TS4000-105A
online

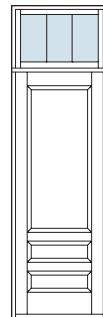

TS3280-104D
online

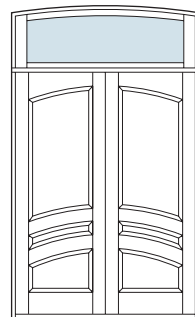

TS3160-504A
online

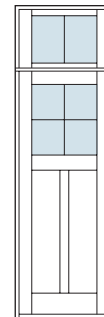

PL234-104C
online

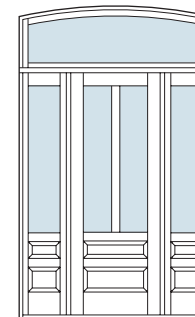

TS4300-308C
pg 76

See more door style options on pages 68-78.





Right: Pair of TS4100 interior doors

MODERN FARMHOUSE

FRESH

RELAXED

UPDATED

TRUSTILE RESILIENT

System Code	FL400-108C
Layout	ES108
Door Style	FL400
Sidelite	FL400
Transom	TRG400
Profile	BV Sticking
Wood Species	Resilient Wood
Finish	SW 9130 Evergreen Fog
Glass	Clear

MODERN FARMHOUSE

TRUSTILE RESERVE

System Code	FL1001-108C
Layout	ES108
Door Style	FL1001
Sidelite	FL501
Transom	TRG400
Profile	BV Sticking/C Panel
Wood Species	Quarter Sawn White Oak
Finish	Grey Mist
Glass	Clear



TRUSTILE RESERVE

System Code	PL104-205C
Layout	ES205
Door Style	PL104
Sidelite	PL102
Profile	SS Sticking/C Panel
Wood Species	Plain Sawn White Oak
Finish	Grey Mist
Glass	Clear

MODERN FARMHOUSE

TRUSTILE RESERVE

System Code	PL106-204A
Layout	ES204
Door Style	PL106
Transom	TRG100
Profile	SS Sticking/C Panel
Wood Species	Walnut
Finish	Amaretto
Glass	Clear

Choose One of Our Featured Entry Systems

Designed by TruStile and ready to order through your local dealer.

Featured Modern Farmhouse Entry Systems in this Catalog

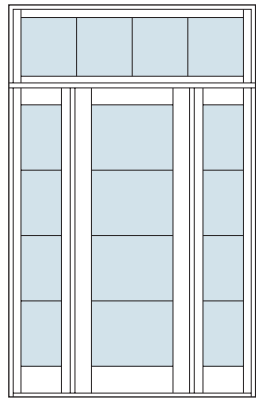

FL400-108C
pg 30

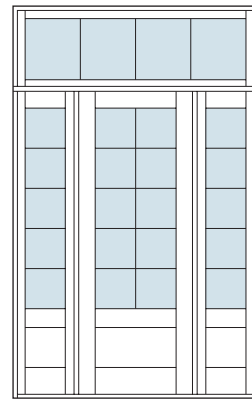

FL1001-108C
pg 32

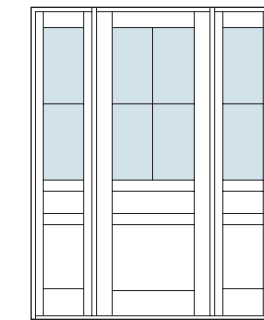

PL224-105C
online

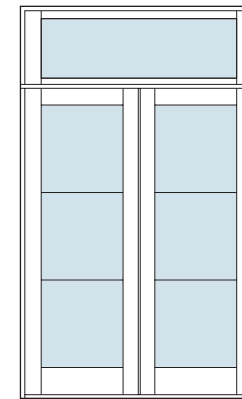

FL300-204A
online

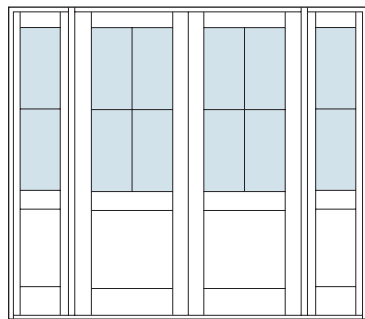

PL104-205C
pg 33

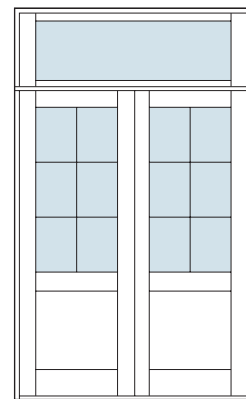

PL106-204A
pg 34

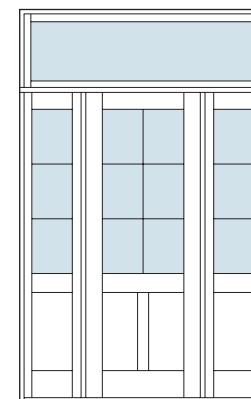

PL206-108C
online

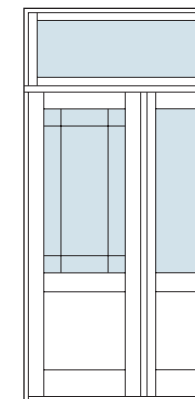

PL119-106D
online

See more door style options on pages 68-78.

Other Featured Modern Farmhouse Entry Systems





FRENCH COUNTRY

ORNATE

CHARMING

ELEGANT

TRUSTILE RESERVE

System Code	TS5030-108D
Layout	ES108
Door Style	TS5030
Sidelite	FL110
Transom	TRG100
Profile	BV Sticking/A Panel
Wood Species	Walnut
Finish	Clear
Glass	Clear

FRENCH COUNTRY

TRUSTILE RESILIENT

System Code	TS3160-201
Layout	ES201
Door Style	TS3160 <i>Common Arch Pair</i>
Profile	OG Sticking/B Panel
Wood Species	Resilient Wood
Finish	SW 6227 Meditative

FRENCH COUNTRY

TRUSTILE RESERVE

System Code	TS4200-105C
Layout	ES105
Door Style	TS4200
Sidelite	TS3130
Profile	OG Sticking/B Panel
Wood Species	Mahogany
Finish	Caramel
Glass	Clear

FRENCH COUNTRY

TRUSTILE RESILIENT

System Code	TS5020-201
Layout	ES201
Door Style	TS5020 <i>Common Arch Pair</i>
Profile	OG Sticking/B Panel
Wood Species	Resilient Wood
Finish	SW 9580 Cracked Pepper
Glass	Beveled

Choose One of Our Featured Entry Systems

Designed by TruStile and ready to order through your local dealer.

Featured French Country Entry Systems in this Catalog

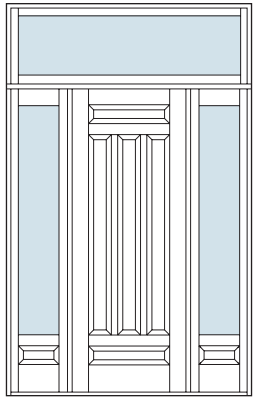

TS5030-108D
pg 36

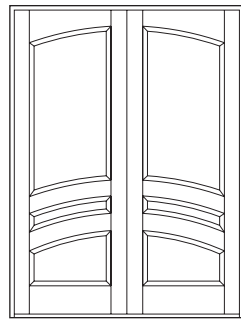

TS3160-201
pg 38

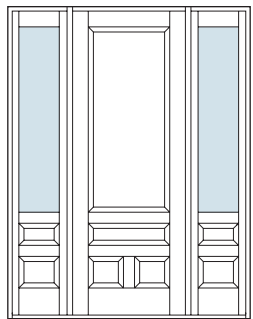

TS4200-105C
pg 39

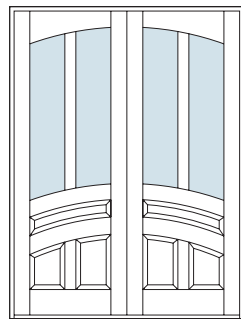

TS5020-201
pg 40

Other Featured French Country Entry Systems

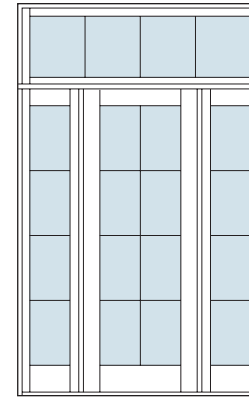

FL800-108C
online

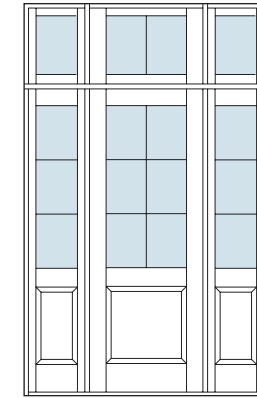

PL106-109C
online



PL109-102C
online

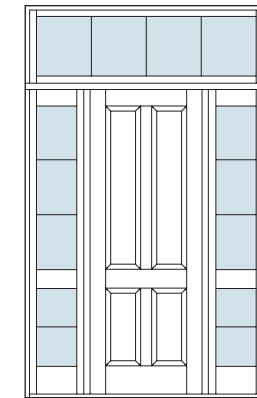

TS4000-108D
online

See more door style options on pages 68-78.





COASTAL*

BREEZY

WELCOMING

CASUAL

TRUSTILE RESERVE

System Code	FL810-105C
Layout	ES105
Door Style	FL810
Sidelite	FL401
Profile	OG Sticking/B Panel
Wood Species	Mahogany
Finish	White Haze
Glass	Clear

* Coastal represents an architectural category only. Impact and hurricane ratings not currently available. See your TruStile dealer to verify compatibility with your local building code.

COASTAL

TRUSTILE RESERVE

System Code	TMP1000-107B
Layout	ES107
Door Style	TMP1000
Sidelite	DSG100
Transom	DSG100
Profile	1/4" Kerf Cut Reveal
Wood Species	Rift Sawn White Oak
Finish	White Haze
Glass	Clear

COASTAL



TRUSTILE RESERVE

System Code	PL145-105C
Layout	ES105
Door Style	PL145
Sidelite	PL145
Profile	SS Sticking/VG Panel
Wood Species	Walnut
Finish	Slate
Glass	Clear

COASTAL

TRUSTILE RESERVE

System Code	TS3130-109C
Layout	ES109
Door Style	TS3130
Sidelite	TS3130
Transom	TRG100
Profile	SS Sticking/C Panel
Wood Species	Rift Sawn White Oak
Finish	Grey Mist
Glass	Clear

Choose One of Our Featured Entry Systems

Designed by TruStile and ready to order through your local dealer.

Featured Coastal Entry Systems in this Catalog

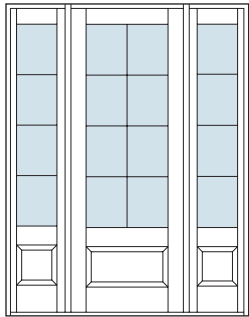

FL810-105C
pg 42

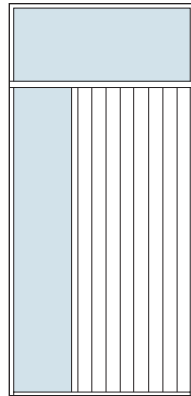

TMP1000-107B
pg 44

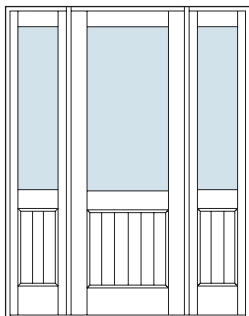

PL145-105C
pg 45

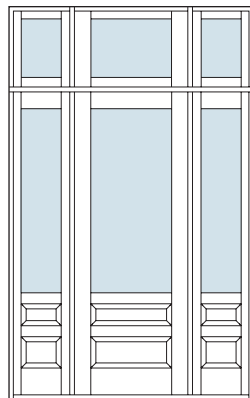

TS3130-109C
pg 46

Other Featured Coastal Entry Systems

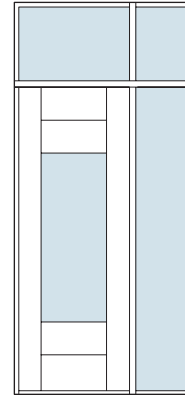

TM9250-115B
online

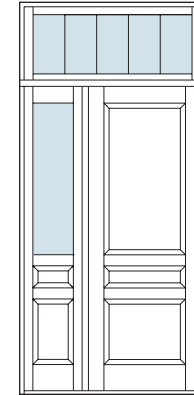

TS3070-106D
online

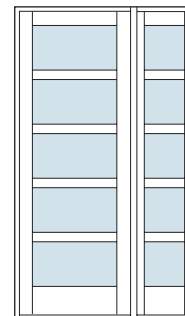

TS5000-102C
online

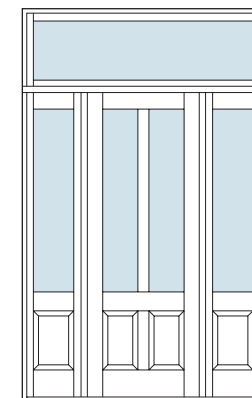

TS4140-108C
online

See more door style options on pages 68-78.





MEDITERRANEAN

WARM

VIBRANT

GRAND

TRUSTILE RESERVE

System Code	PL145-201
Layout	ES201
Door Style	PL145
Profile	QB Sticking/VG Panel
Wood Species	Walnut
Finish	Clear
Glass	Clear

MEDITERRANEAN

TRUSTILE RESERVE

System Code	TS3130-201
Layout	ES201
Door Style	TS3130
Profile	BM Sticking/B Panel
Wood Species	Walnut
Finish	Slate

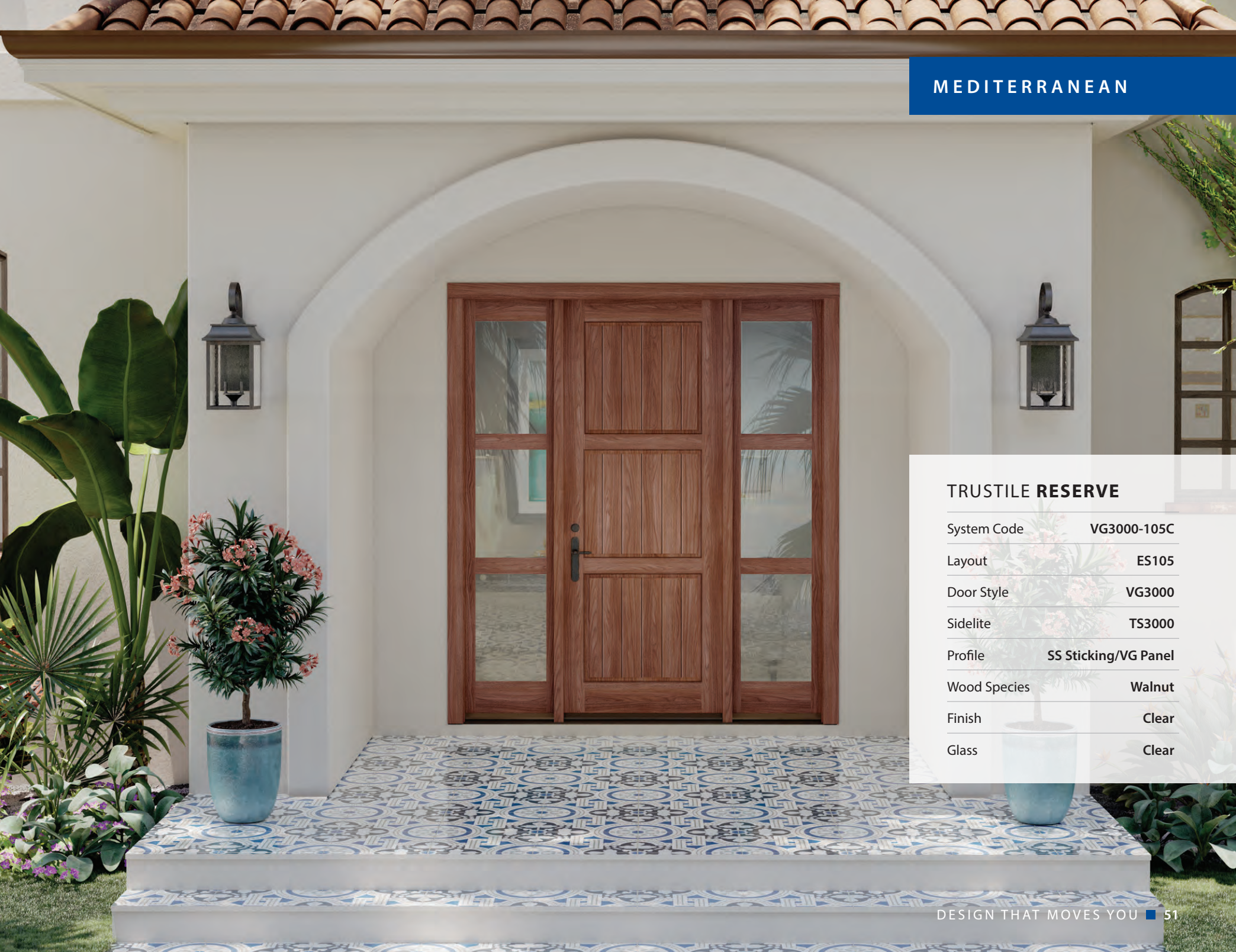

TRUSTILE RESERVE

System Code	VG3000-105C
Layout	ES105
Door Style	VG3000
Sidelite	TS3000
Profile	SS Sticking/VG Panel
Wood Species	Walnut
Finish	Clear
Glass	Clear

MEDITERRANEAN

TRUSTILE RESILIENT

System Code	VG1000-101
Layout	ES101
Door Style	VG1000
Profile	Standard V-Groove
Wood Species	Resilient Wood
Finish	SW 6328 Fireweed

Choose One of Our Featured Entry Systems

Designed by TruStile and ready to order through your local dealer.

Featured Mediterranean Entry Systems in this Catalog

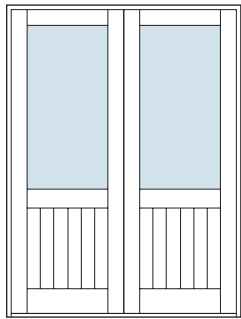

PL145-201
pg 48

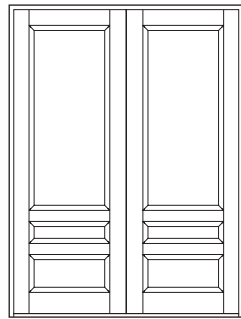

TS3130-201
pg 50

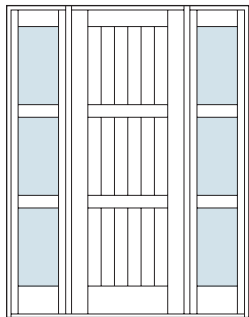

VG3000-105C
pg 51

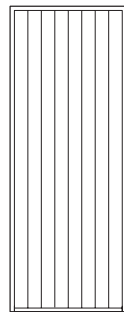

VG1000-101
pg 52

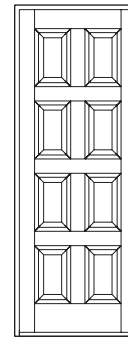

TS8000-101
online

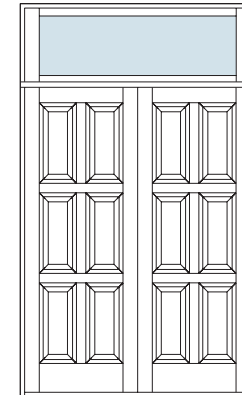

TS6080-105
online

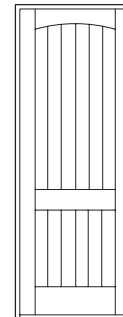

VG2020-101
online

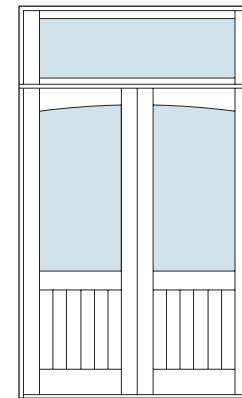

PL176-204A
online

See more door style options on pages 68-78.





CRAFTSMAN

AUTHENTIC

PRECISE

COMFORTING

TRUSTILE RESERVE

System Code	PL333-105C
Layout	ES105
Door Style	PL333 (Small Dentil Bird Ledge)
Sidelite	PL130 (Small Dentil Bird Ledge)
Profile	SS Sticking/C Panel
Wood Species	Plain Sawn White Oak
Finish	Grey Mist
Glass	Clear

CRAFTSMAN

TRUSTILE RESERVE

System Code	FL618-205C
Layout	ES205
Door Style	FL618 (Common Arch Pair)
Sidelite	FL315 (Common Arch Pair)
Profile	QR Sticking/B Panel
Wood Species	Mahogany
Finish	White Haze
Glass	Clear

CRAFTSMAN

TRUSTILE RESILIENT

System Code	PL236-109C
Layout	ES109
Door Style	PL236
Sidelite	PL104
Transoms	TRG200 and TRG300
Profile	SS Sticking/C Panel
Wood Species	Resilient Wood
Finish	SW 7006 Extra White
Glass	Clear

CRAFTSMAN

TRUSTILE RESERVE

System Code	PL243-105C
Layout	ES105
Door Style	PL243 (Small Dentil Bird Ledge)
Sidelite	PL232 (Small Dentil Bird Ledge)
Profile	SS Sticking/C Panel
Wood Species	Rift Sawn White Oak
Finish	Hazelnut
Glass	White Lami

Choose One of Our Featured Entry Systems

Designed by TruStile and ready to order through your local dealer.

Featured Craftsman Entry Systems in this Catalog

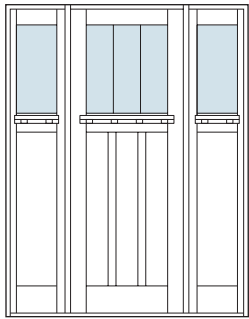

PL333-105C
pg 54

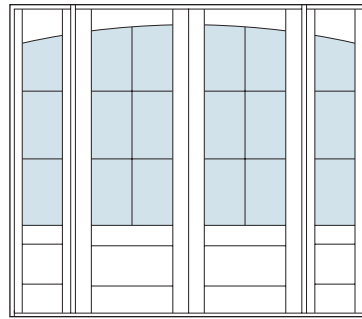

FL618-205C
pg 56

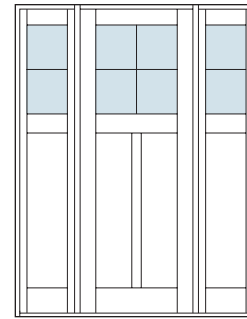

PL234-105C
online

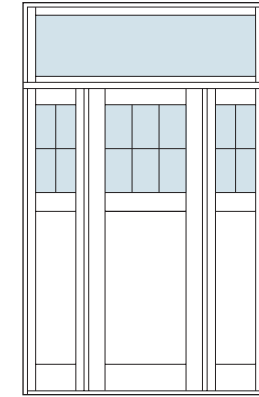

PL136-108C
online

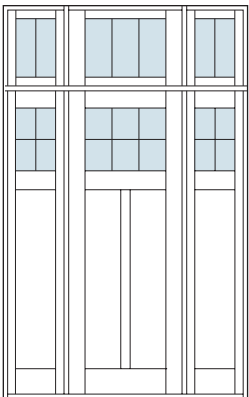

PL236-109C
pg 57

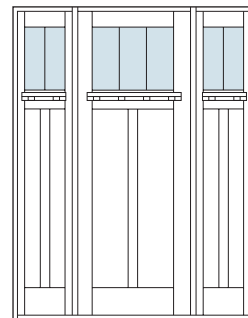

PL243-105C
pg 58

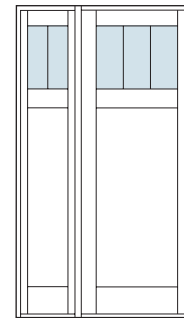

PL143-103C
online

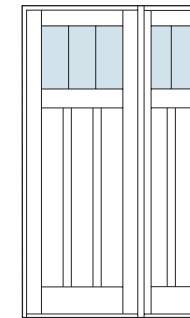

PL343-102C
online

Other Featured Craftsman Entry Systems

See more door style options on pages 68-78.





CAPE COD

HISTORIC AMBITIOUS STATELY

TRUSTILE RESERVE

System Code	PL224-109C
Layout	ES109
Door Style	PL224
Sidelite	PL222
Transoms	TRG100
Profile	OG Sticking/A Panel
Wood Species	Rift Sawn White Oak
Finish	Ebony
Glass	Clear

CAPE COD

TRUSTILE RESERVE

System Code	PL106-308C
Layout	ES308
Door Style	PL106
Sidelite	PL103
Transom	TRG110
Profile	QR Sticking/A Panel
Wood Species	Plain Sawn White Oak
Finish	Hazelnut
Glass	White Lami

CAPE COD

TRUSTILE RESERVE

System Code	TS2210-105C
Layout	ES105
Door Style	TS2210
Sidelite	TS2210
Profile	CB Sticking/B Panel
Wood Species	Walnut
Finish	Champagne
Glass	Clear

CAPE COD

TRUSTILE RESILIENT

System Code	PL224-101
Layout	ES101
Door Style	PL224
Profile:	CB Sticking/A Panel
Wood Species	Resilient Wood
Finish	SW 0018 Teal Stencil
Glass	Clear

Choose One of Our Featured Entry Systems

Designed by TruStile and ready to order through your local dealer.

Featured Cape Cod Entry Systems in this Catalog

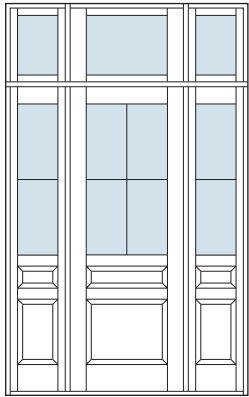

PL224-109C
pg 60

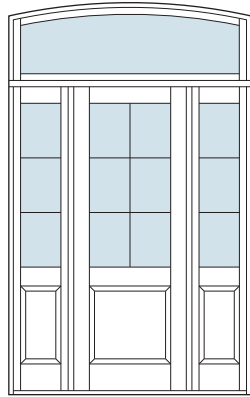

PL106-308C
pg 62

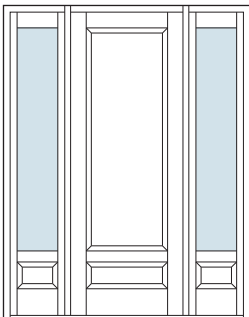

TS2210-105C
pg 63

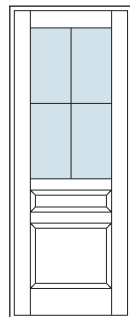

PL224-101
pg 64

Other Featured Cape Cod Entry Systems

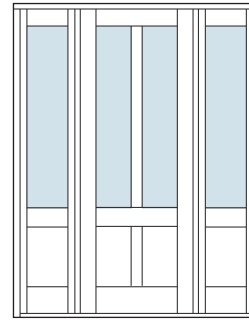

TS4140-105C
pg 75

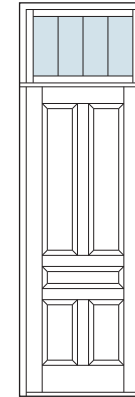

TS5060-104D
online



PL109-109C
online

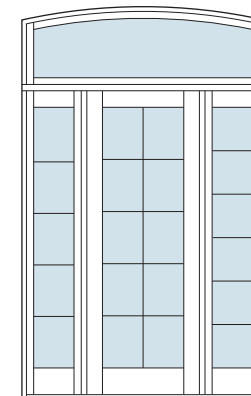

FL1000-308C
online

See more door style options on pages 68-78.

Entry System Layouts

Begin every project by selecting your entry system layout. From a single door, or a door and one sidelite, to a pair of doors with matching sidelites and transoms, this key will get you off to the right start.

SINGLE DOOR SYSTEMS

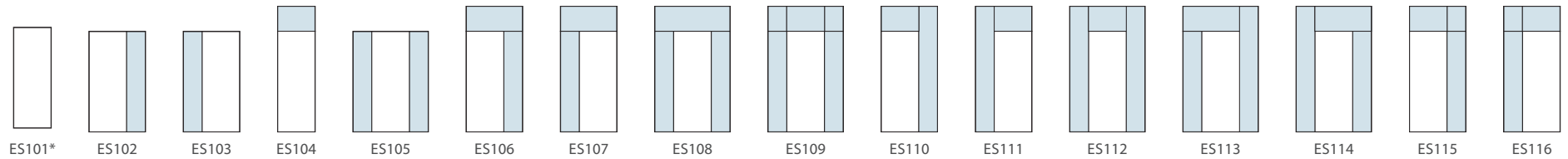

PAIRED DOOR SYSTEMS

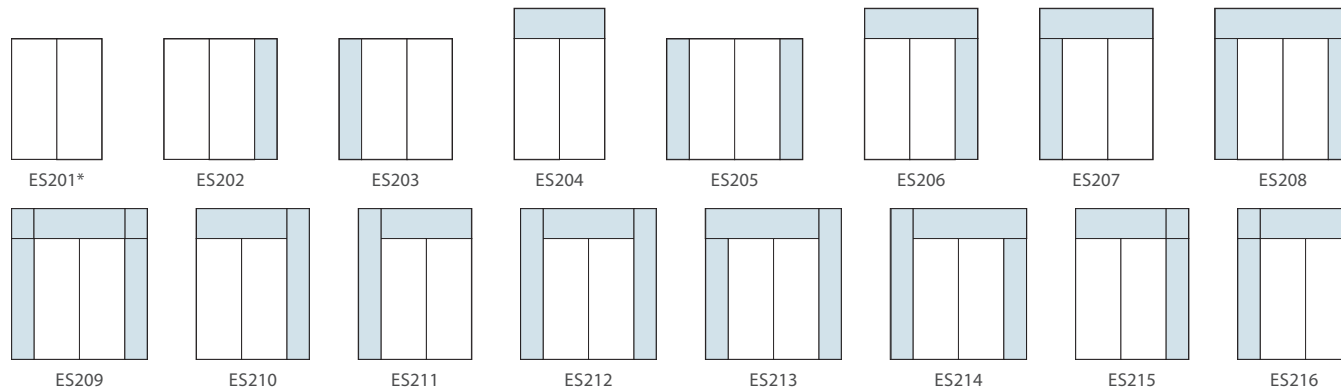

ARCH- AND RADIUS-TOP SYSTEMS **



* ES101 and ES201 are available for TruStile Resilient Wood Entry Systems™ with no overhang applications.

** Arch- and radius-top systems are only available on TruStile Reserve Wood Entry Systems™. VG door styles not available with radius or arch tops.



TRUSTILE (TS) SERIES

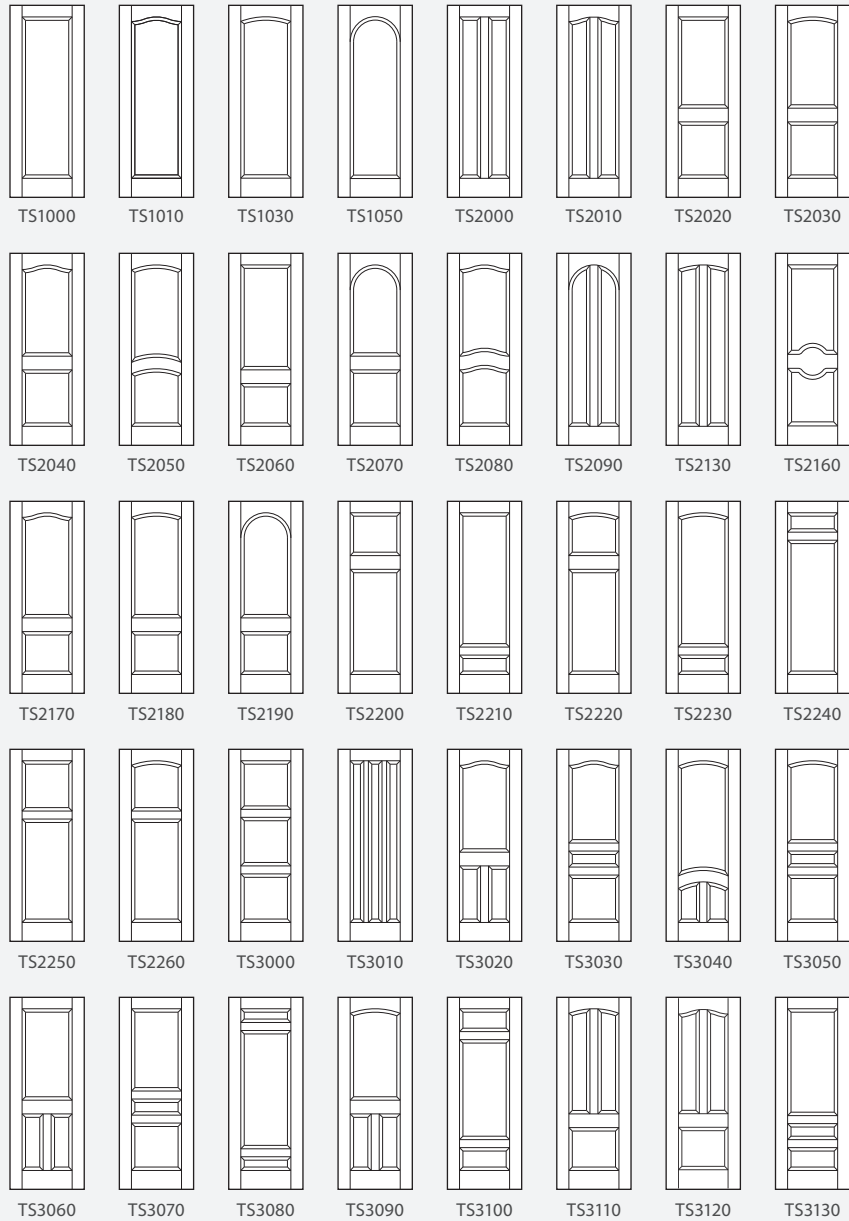

TRUSTILE (TS) SERIES

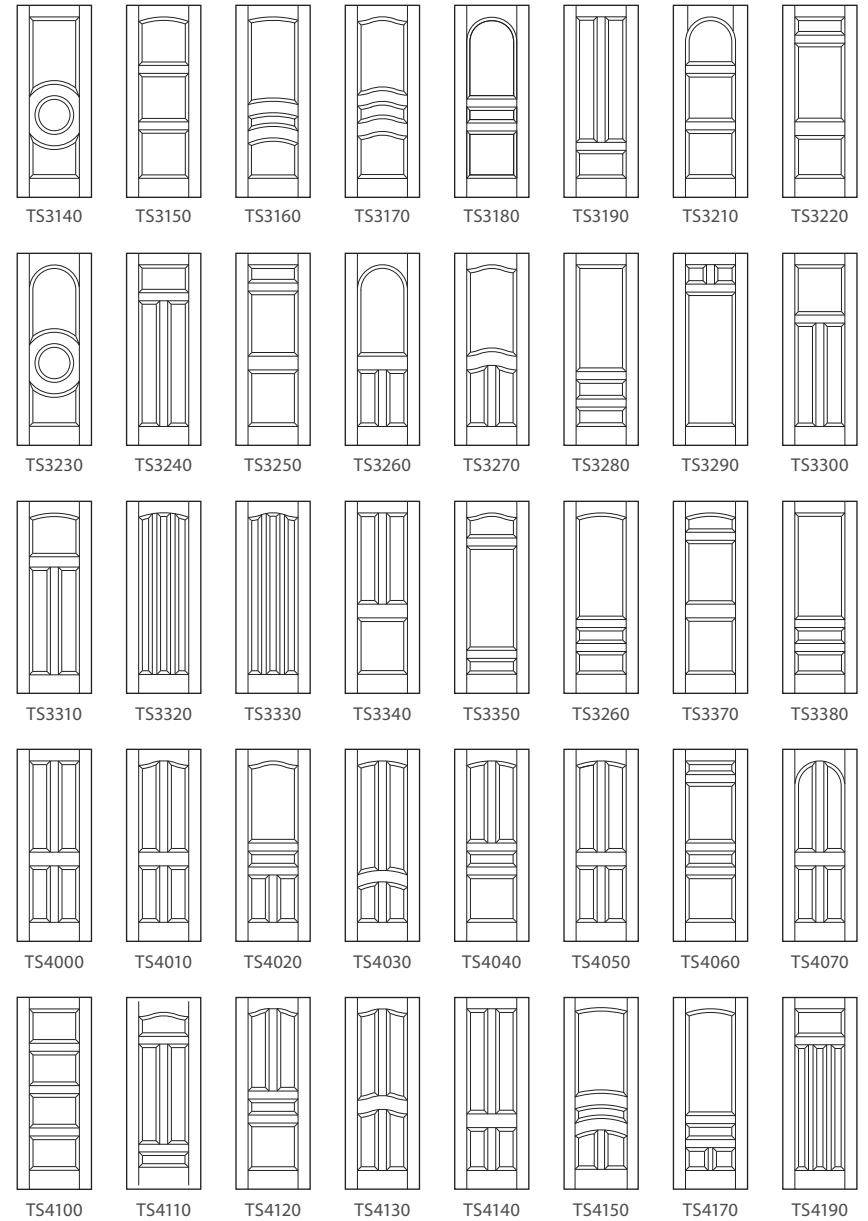



TruStile Resilient TS3070-201A
See page 23 for complete specs.



TruStile Reserve TS4140-105C
with PL100 sidelites.

TRUSTILE (TS) SERIES

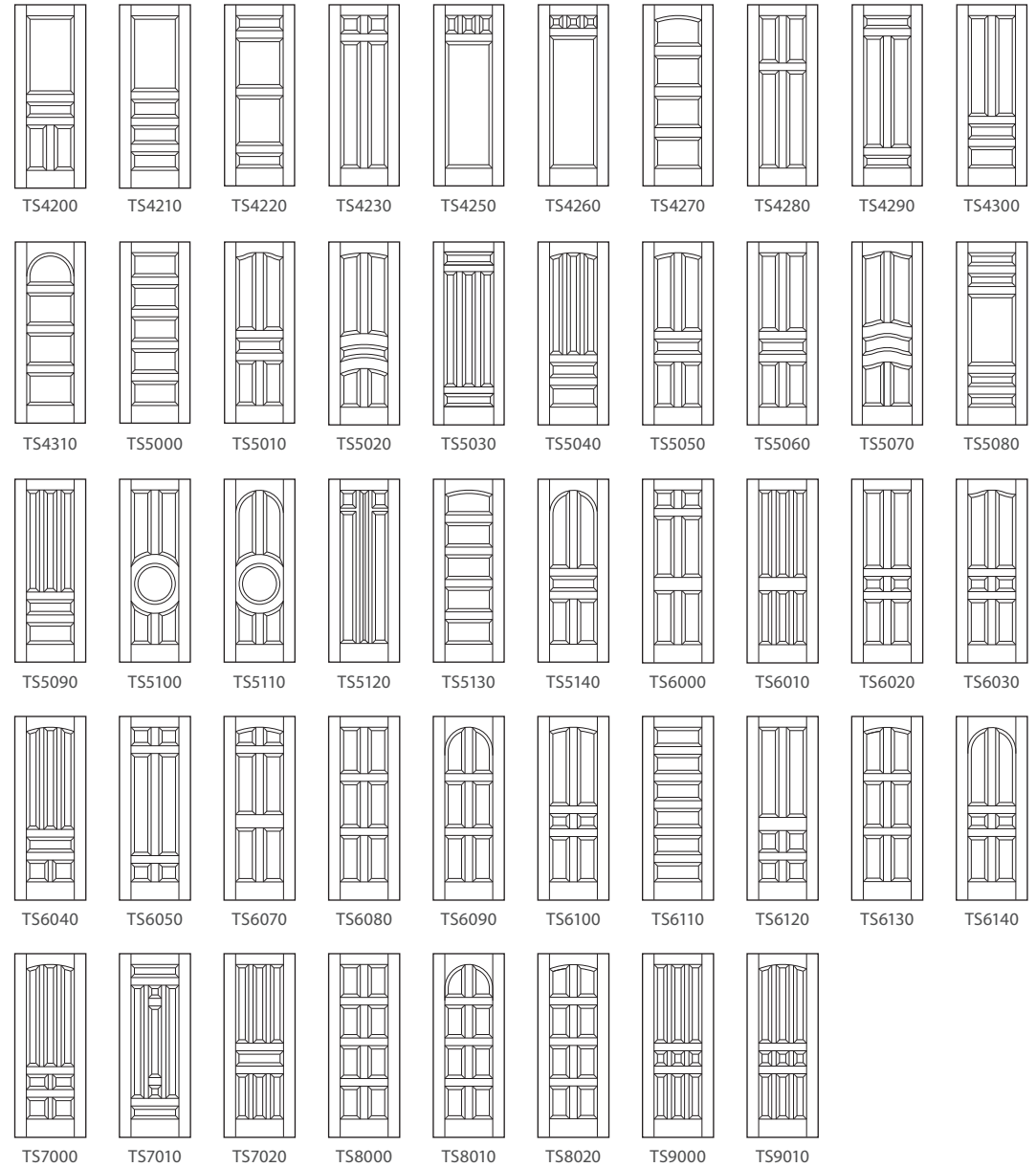

FRENCH LITE (FL) SERIES



* These styles only available as sidelites.



TruStile Resilient FL400-108C
See page 31 for complete specs.

FRENCH LITE (FL) SERIES

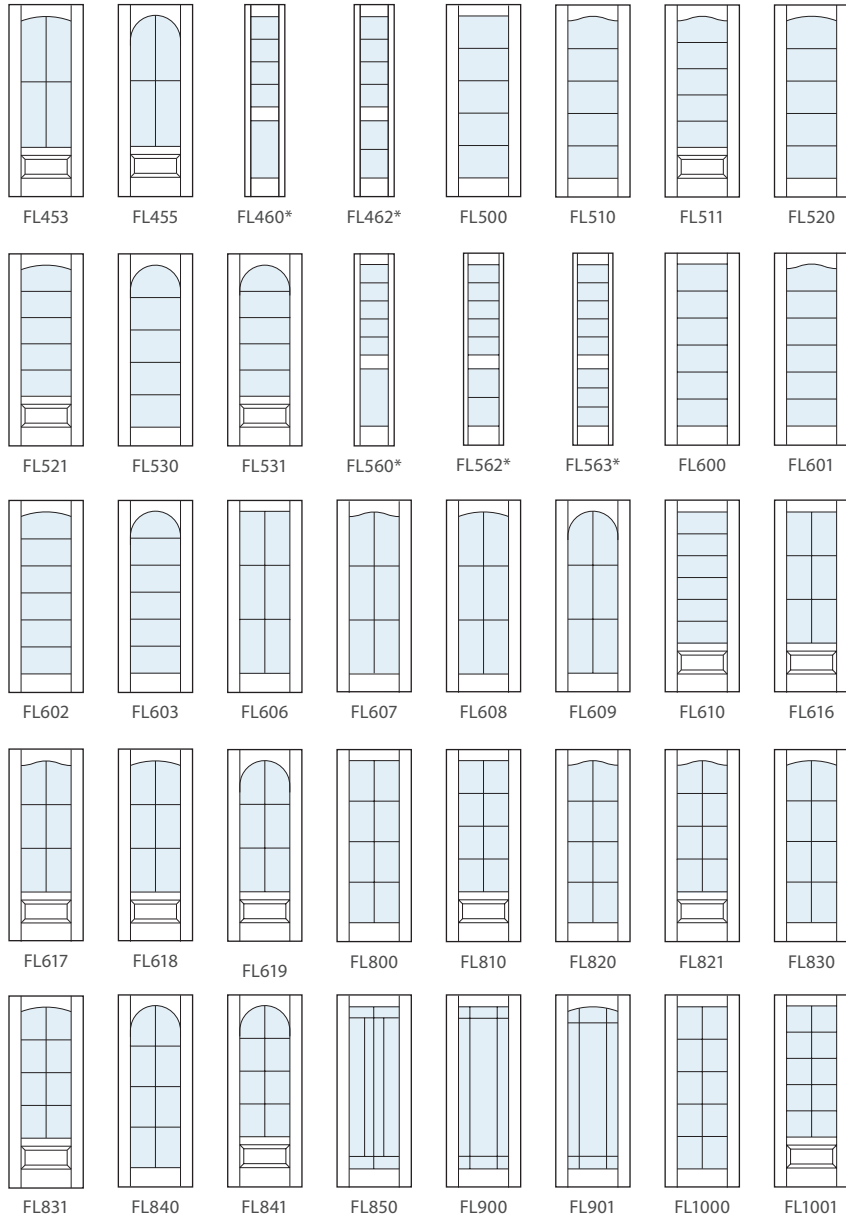

FRENCH LITE (FL) SERIES

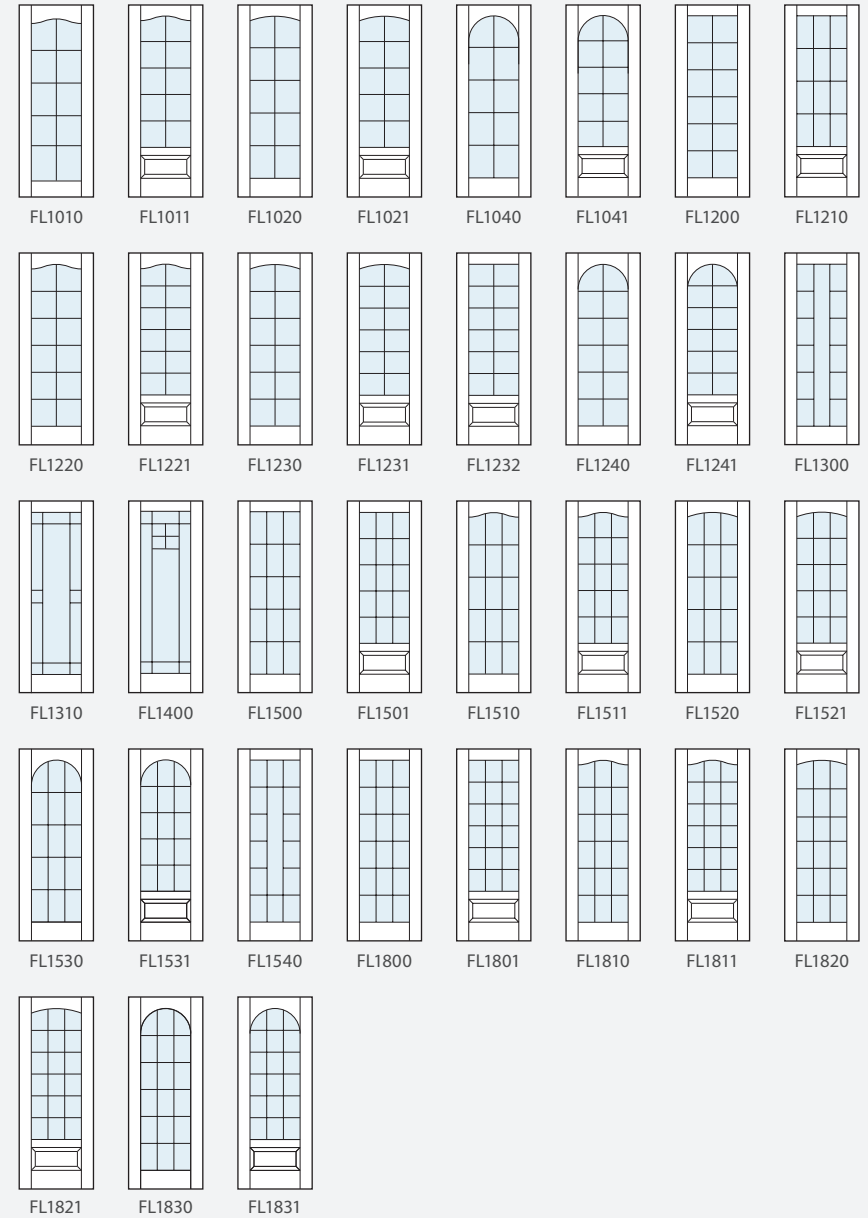

* These styles only available as sidelites.

PANEL LITE (PL) SERIES

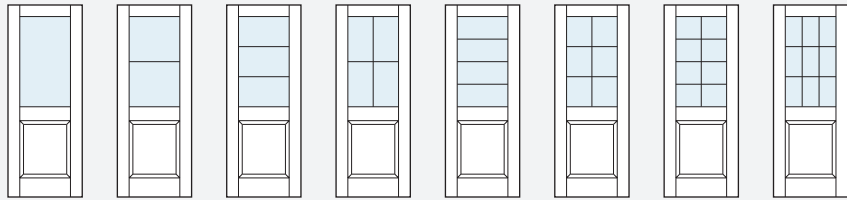

PL100 PL102 PL103 PL104 PL105 PL106 PL108 PL109

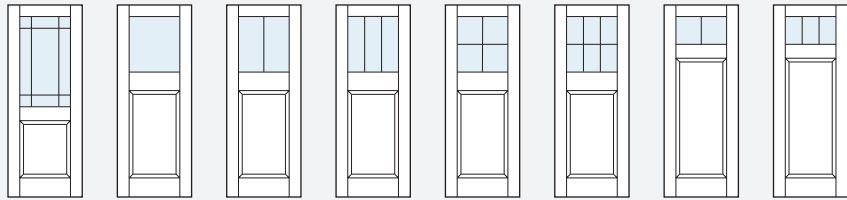

PL119 PL130 PL132 PL133 PL134 PL136 PL142 PL143

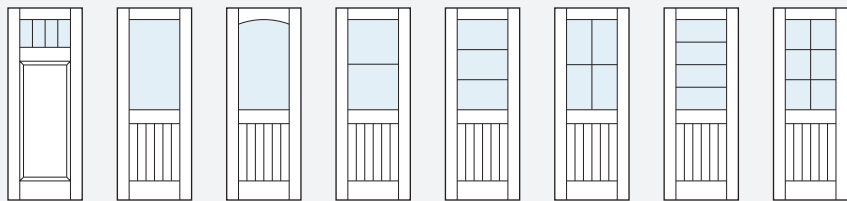

PL144 PL145 PL146 PL152 PL153 PL154 PL155 PL156



PL158 PL159 PL160 PL162 PL163 PL164 PL165 PL166

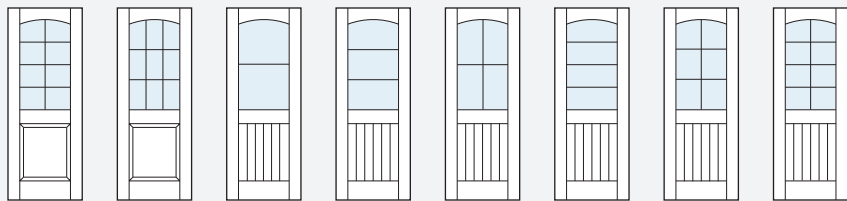

PL168 PL169 PL172 PL173 PL174 PL175 PL176 PL178

PANEL LITE (PL) SERIES

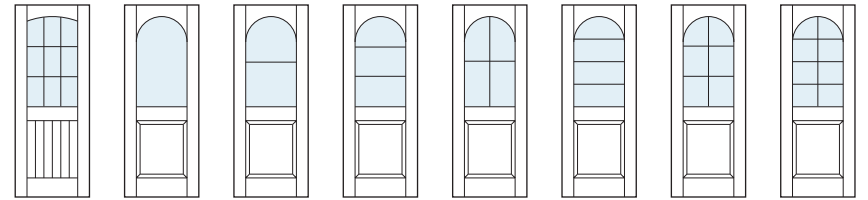

PL179 PL180 PL182 PL183 PL184 PL185 PL186 PL188

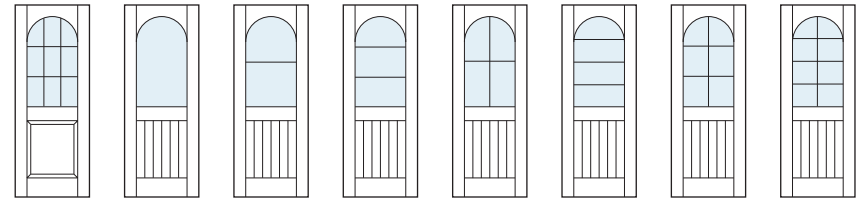

PL189 PL190 PL192 PL193 PL194 PL195 PL196 PL198

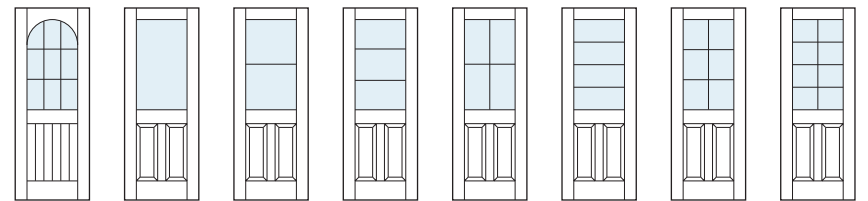

PL199 PL200 PL202 PL203 PL204 PL205 PL206 PL208

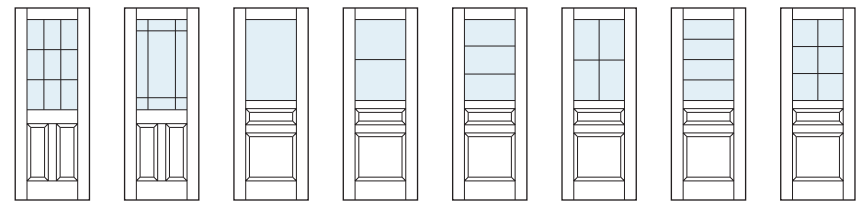

PL209 PL219 PL220 PL222 PL223 PL224 PL225 PL226

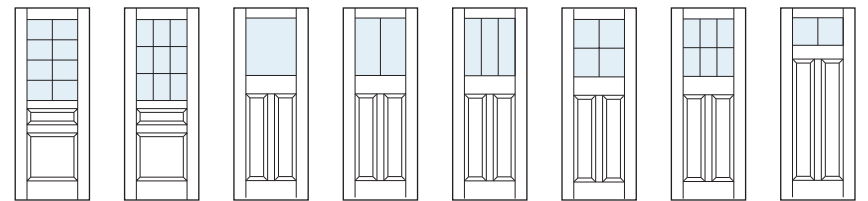

PL228 PL229 PL230 PL232 PL233 PL234 PL236 PL242



PANEL LITE (PL) SERIES

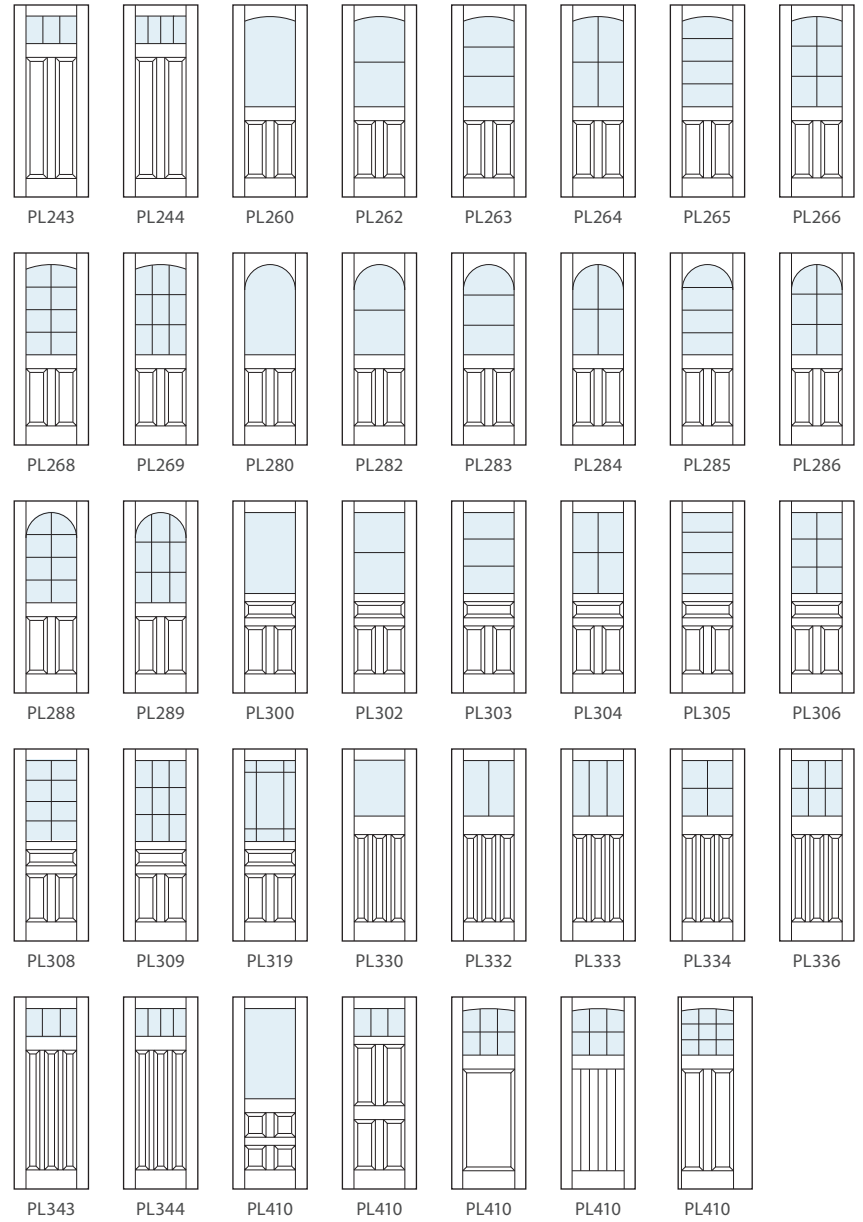

PANEL LITE (PL) SERIES

TruStile Resilient PL224-101
See page 64 for complete specs.

TRU&MODERN (TM) SERIES

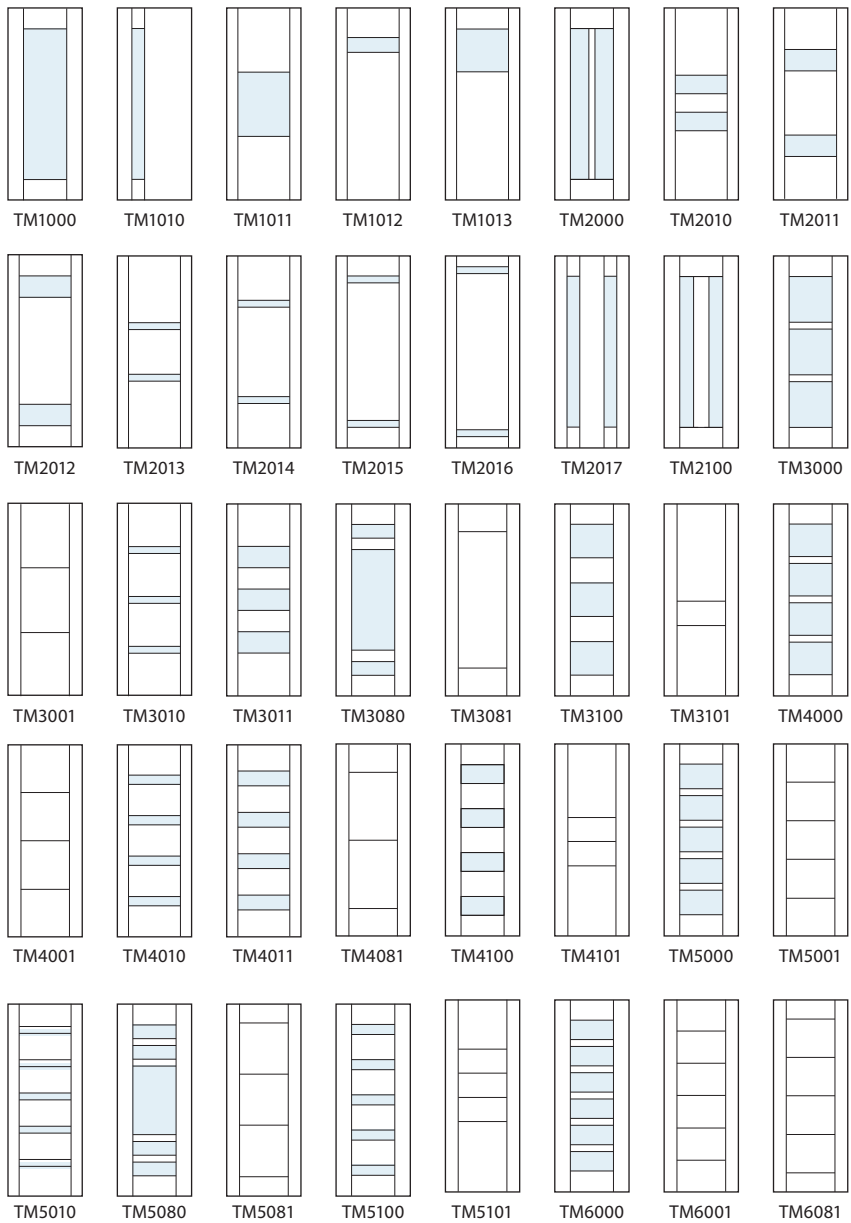

TruStile Reserve TM9350-105A
See page 18 for complete specs.



TRU&MODERN (TM) SERIES

TM6100	TM6101	TM8000	TM8100	TM9000	TM9100	TM9110	TM9120	TM9130	TM9140
TM9150	TM9160	TM9200	TM9210	TM9220	TM9230	TM9240	TM9250	TM9260	TM9270
TM9300	TM9310	TM9320	TM9330	TM9340	TM9350	TM13000	TM13100	TM13110	TM13120
TM13130	TM13140	TM13150	TM13160	TM13200	TM13210	TM13220	TM13230	TM13240	TM13250
TM13260	TM13270	TM13300	TM13310	TM13320	TM13330	TM13340	TM13350	TM13360	TM13370





TruStile Reserve TMIR6000-106B
See page 17 for complete specs.

TRU&MODERN INFINITE RAIL (TMIR) SERIES

TMIR1001	TMIR1002	TMIR1012	TMIR1014	TMIR2000	TMIR2001	TMIR2011	TMIR2012	TMIR2200	TMIR3000
TMIR3001	TMIR3080	TMIR3081	TMIR3100	TMIR3101	TMIR3200	TMIR4000	TMIR4001	TMIR4002	TMIR4008
TMIR4020	TMIR4080	TMIR4081	TMIR4100	TMIR4101	TMIR4200	TMIR5000	TMIR5001	TMIR5080	TMIR5081
TMIR5100	TMIR5101	TMIR6000	TMIR6001	TMIR6080	TMIR6081	TMIR6100	TMIR6101	TMIR7000	TMIR8000
TMIR9000	TMIR9001	TMIR10000	TMIR11000	TMIR12000	TMIR13000				

TRU&MODERN INFINITE RAIL (TMIR) SERIES

TRU&MODERN FLUSH (TMF) SERIES





TruStile Resilient TMFG5010-105A

TRU&MODERN FLUSH WITH GLASS (TMFG) SERIES

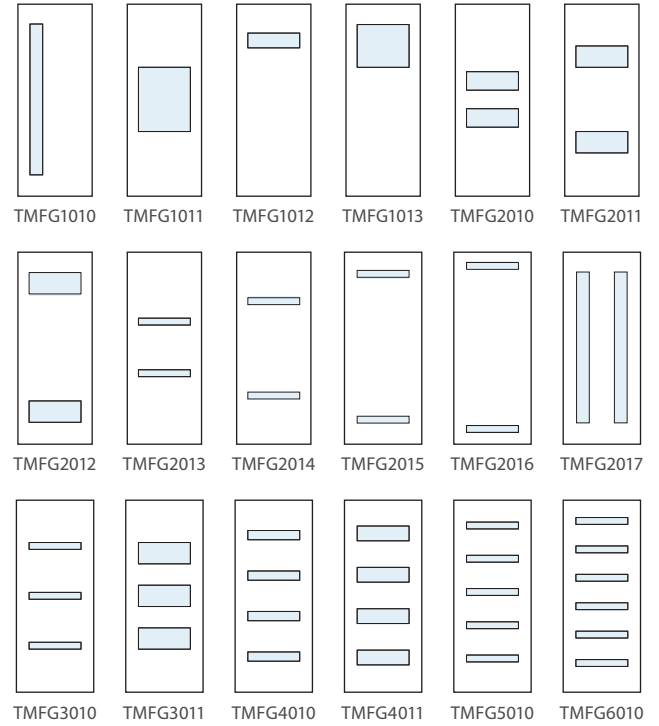

FLUSH DOOR STYLES (TMF & TMFG SERIES)



TruStile Resilient VG1000-101
See page 52 for complete specs.

TRU&MODERN PLANK (TMP) SERIES

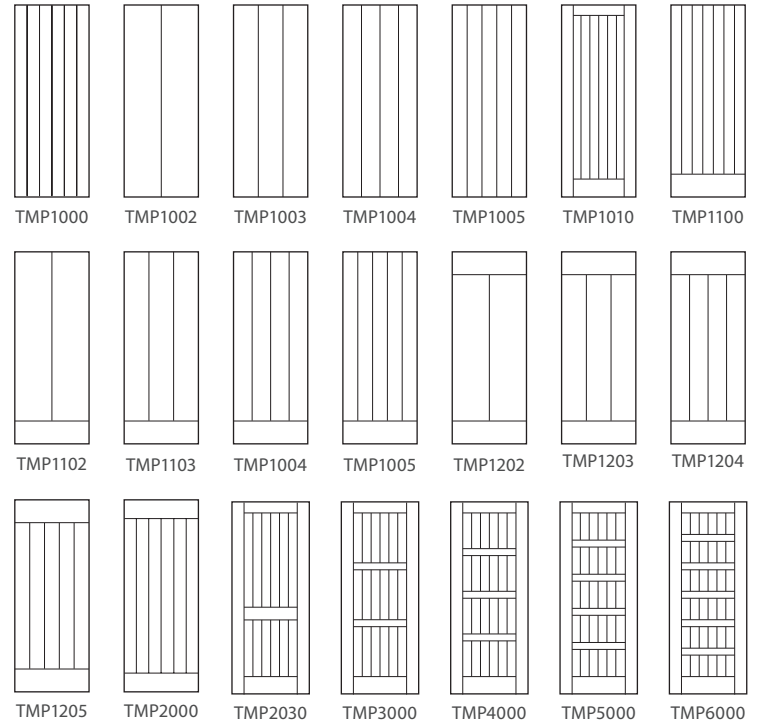

V-GROOVE (VG) SERIES

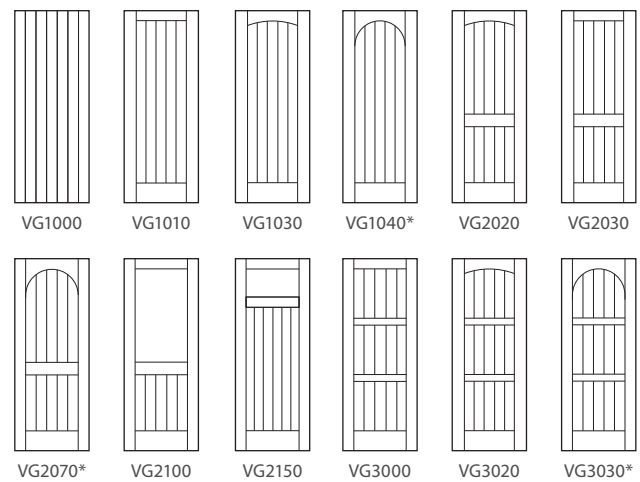

* Resilient only



TruStile Resilient TS3070-201
See page 44 for complete specs.



Resilient TS4200-101 outswing entry system with One Step (OS) sticking and Raised (A) panel.

Outswing Doors for Residential Applications

The Resilient and Reserve Wood Entry System is available for residential outswing applications including porch, side of house, and garage entrances.

TruStile Resilient Entry Systems™

- Engineered with resilient Accoya® and Tricoya® — acetylated wood solutions that bring unprecedented reliability and durability to wood for painted outdoor applications.
- Available in single and double door configurations, featuring an aluminum outswing sill with an oak threshold. Transoms and sidelites are not yet available.
- Features Emtek® solid brass non-removable pin hinges paired with a solid Accoya® frame for maximum performance.
- GU-Secury Automatic multipoint lock required for applications without an overhang and dark painted colors.
- Most configurations are delivered pre-hung with a premium prime finish, ready to paint to match your design.
- 10-year warranty available on residential projects with reduced and no overhang openings, depending on system design specifications.

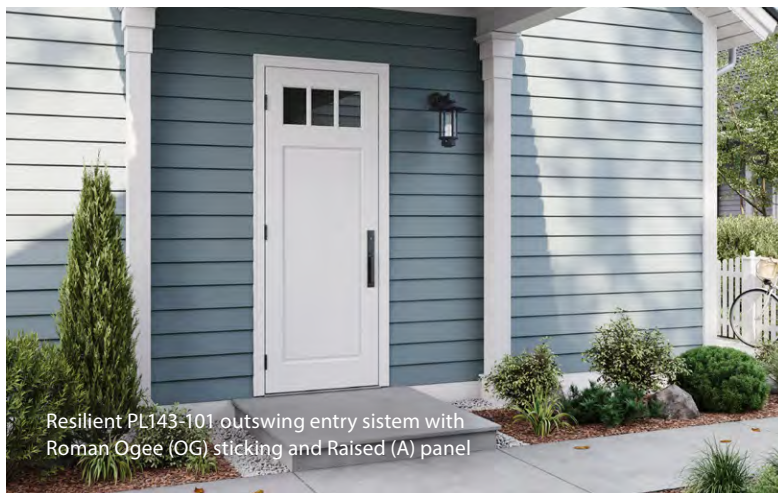

Resilient PL143-101 outswing entry system with Roman Ogee (OG) sticking and Raised (A) panel

TruStile Reserve Entry Systems™

- Elevates the refined elegance of your home with the beauty of stained natural wood.
- Engineered with a laminated veneer lumber (LVL) core and Tricoya® layers to provide exceptional stability and durability.
- Single doors and double doors (per leaf) available up to 48" wide and 120" tall.
- 10 natural wood species available with an extensive collection of premium factory stain options.
- Premium appearance standards ensure industry-leading grain and color matching.
- 5-year limited warranty on residential projects, with industry standard overhang requirements.
- Features Emtek® solid brass non-removable pin hinges.



Reserve FL451-101 outswing entry system in select alder with White Haze finish, Bevel (BV) sticking, Raised (F) panel and clear glass.

Transoms

Select from this extensive collection of transoms to complement your entry door.



IN-SASH SQUARE TRANSOMS



ARCH- AND RADIUS-TOP TRANSOMS



DIRECT SET SIDELITES AND TRANSOMS

Available in 1- to 18-lites.

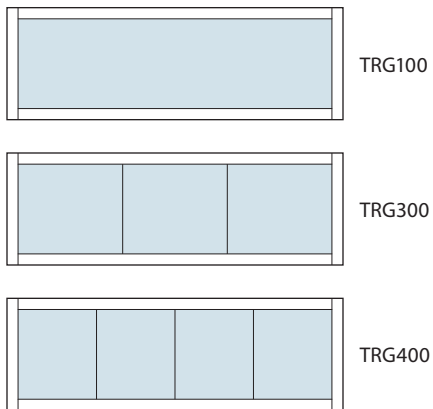

Available only for TruStile Reserve

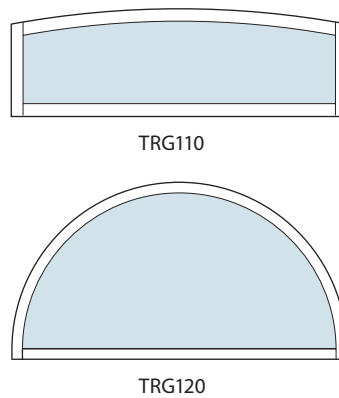

Maximize the amount of natural light available.

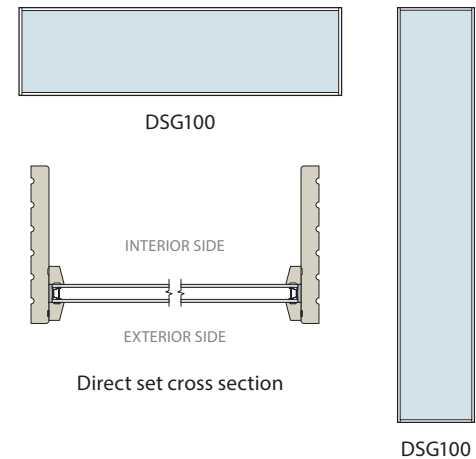

Sidelites

Select from this extensive collection of sidelites to complement your entry door. Many panel doors available with glass options.



ONE-LITE IN-SASH SIDELITES



COMPLEMENTARY SIDELITES



MATCHING DOOR SIDELITES

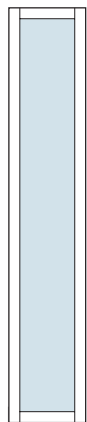

A one-lite in-sash sidelite is a classic look that brings natural light into your entrance.

Order sidelites with stiles and rails as narrow as 1-7/8".

We offer a wide selection of sidelites to complement your door style.

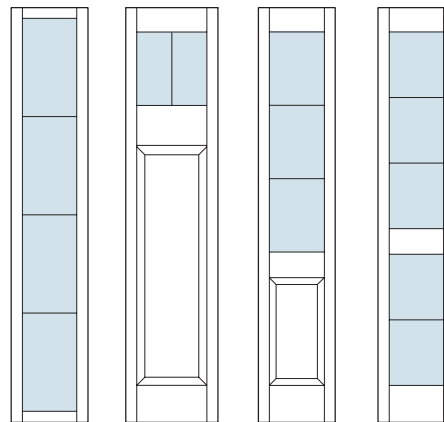

FL400

PL142

pl103

FL362

Many door styles are available as a matching sidelite.

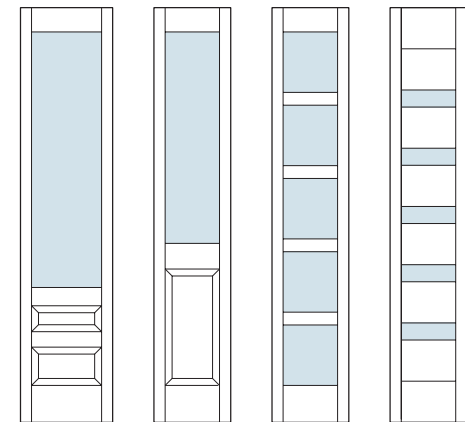

TS3130

pl100

TS5000

TM9340

Note: Most door styles on pages 68-78 can be selected as a sidelite.

Resilient and Reserve Wood Entry Systems Construction

In collaboration with our parent company, Marvin®, we have engineered a family of premium entry systems that don't just transform a space, but how you feel inside it.

TruStile Entry Systems have been extensively tested and proven in partnership with the Marvin Research and Development team.

Resilient Wood Entry Systems™

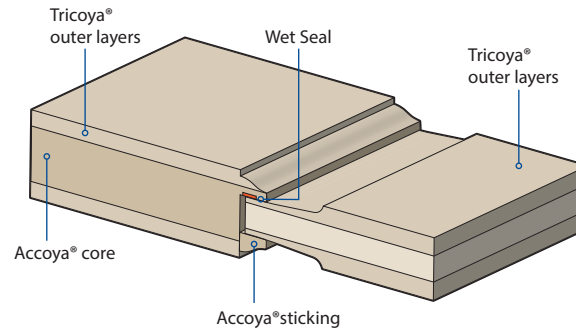

Stile & Rail Door Construction

Reserve Wood Entry Systems™

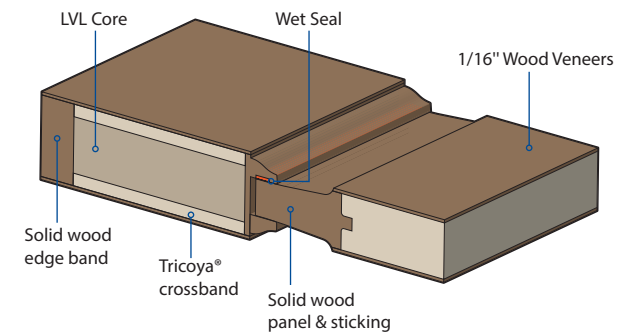

Stile & Rail Door Construction

So, What is Acetylation?

Acetylation is a process used to enhance the naturally-occurring properties of wood. In simple terms, it 'pickles' the wood, reducing how much water the cells in the wood can absorb.

The process uses acetic anhydride, a derivative of vinegar, to change hydroxyl groups in the wood (which like water) into acetyl groups (which don't like water), resulting in improved performance characteristics without harmful or environmentally unfriendly additives.

Altogether, this means the wood shrinks and swells much less when wet, and is much less susceptible to decay or insect attack. The finished product is highly durable and dimensionally stable, outperforming all known species of wood.

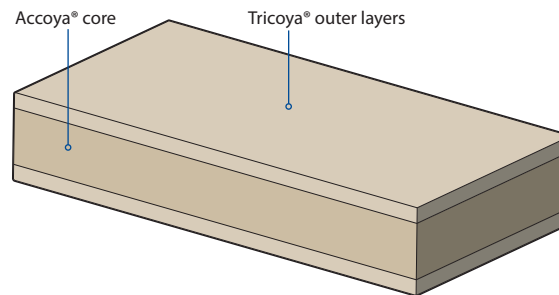

Flush Door Construction

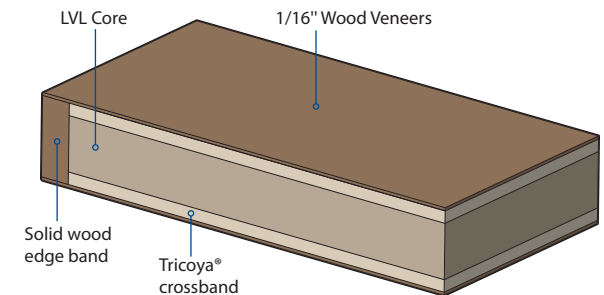

Flush Door Construction

Wood Performance Every Home Can Rely On

Learn more about the innovative, durable materials used in making our entry systems.



As the sister brand to Accoya®, Tricoya® is an acetylated wood panel product that achieves the same ultra-high levels of durability and stability in the most extreme and challenging climates and outdoor applications. Tricoya is used as a stable core material within the Reserve™ Wood Entry system and a durable, paintable surface layer of our Resilient™ Entry system.

- Doesn't shrink or swell like other wood products
- Superior paintability and consistent surface across the entire door
- Complies with CARB 93120 for No Added Formaldehyde



Accoya® is an acetylated, modified wood product that is unsurpassed when it comes to durability, stability and withstanding the test of any climate.

As part of the TruStile Resilient™ Entry System, Accoya® is used for the core and frame components for durability, stability, and superior rot resistance.

- Doesn't shrink or swell like other wood species
- 100% real wood. A sustainable and durable material
- Solid wood core provides superior screw holding on door edge



Profile Options

PANEL PROFILES

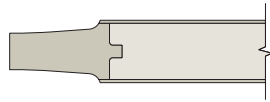

Raised (A) Panel

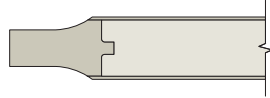

Scoop (B) Panel
Also available with bladder-press panel



Flat (C) Panel

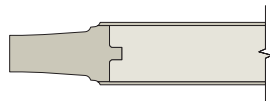

Double Hip (D) Panel

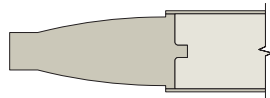

Senior Raised (E) Panel

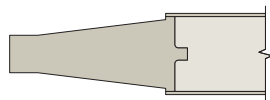

Senior Bevel (F) Panel

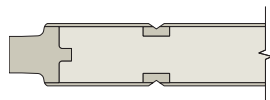

Standard V-Groove (VG) Panel

STICKING PROFILES



Square Stick (SS) Sticking

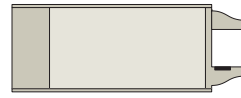

Roman Ogee (OG) Sticking

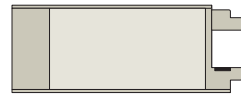

One Step (OS) Sticking

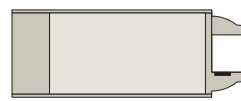

Quarter Bead (QB) Sticking

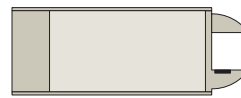

Quarter Round (QR) Sticking

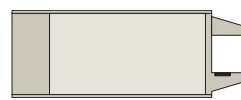

Bevel (BV) Sticking

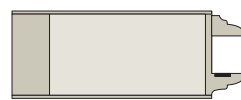

Cove & Bead (CB) Sticking

APPLIED MOULDINGS



Cove (CV) Applied Moulding

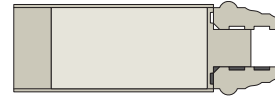

Low Profile Bolection (LP) Moulding

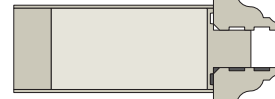

Bolection (BM) Moulding



Big Bolection (BB) Moulding

SIMULATED DIVIDED LITE BARS (SDL)

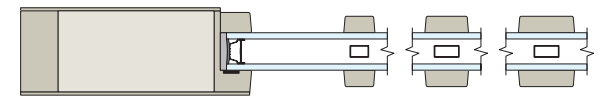

Square Stick (SS) SDL Glass

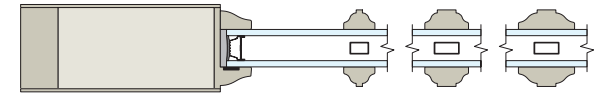

Roman Ogee (OG) SDL Glass

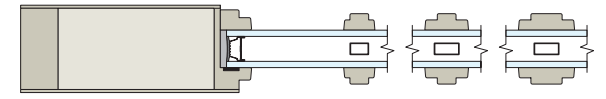

One Step (OS) SDL Glass

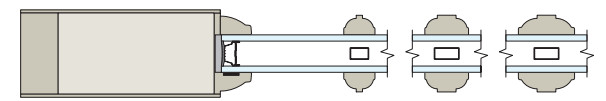

Quarter Bead (QB) SDL Glass

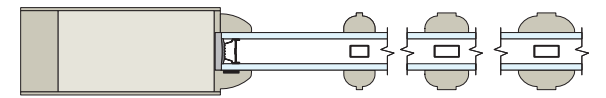

Quarter Round (QR) SDL Glass

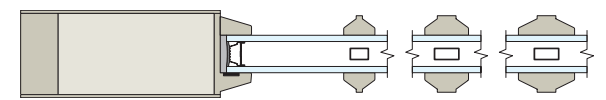

Bevel (BV) SDL Glass

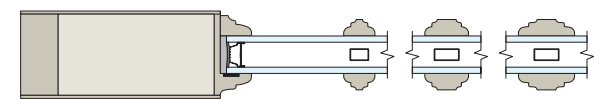

Cove & Bead (CB) SDL Glass

TRUE DIVIDED LITE BARS (TDL)

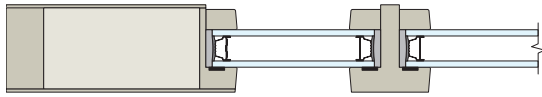

Square Stick (SS) TDL Glass

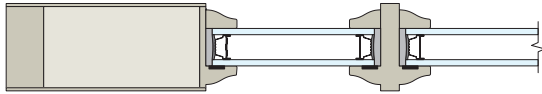

Roman Ogee (OG) TDL Glass

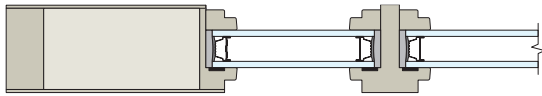

One Step (OS) TDL Glass

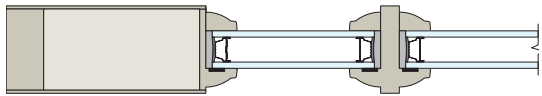

Quarter Bead (QB) TDL Glass

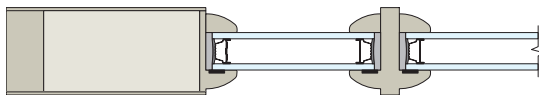

Quarter Round (QR) TDL Glass

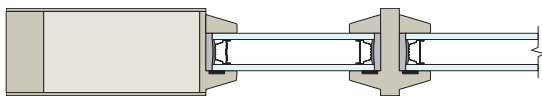

Bevel (BV) TDL Glass

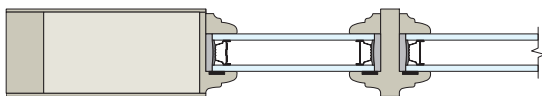

Cove & Bead (CB) TDL Glass

Frame Profile and Mull Construction

All Reserve Wood frame parts undergo a wood dip treatment to protect against fungus and insects. Resilient Wood frames don't require dipping.

FRAME OPTIONS

UNIFRAME MULL POST OPTIONS

Single Rabbet Frame with Back-to-Back Mull Posts

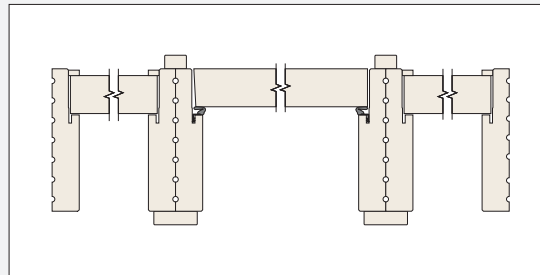

Default for all door applications

Single Rabbet Frame with 4 9/16" Uniframe Mull Posts

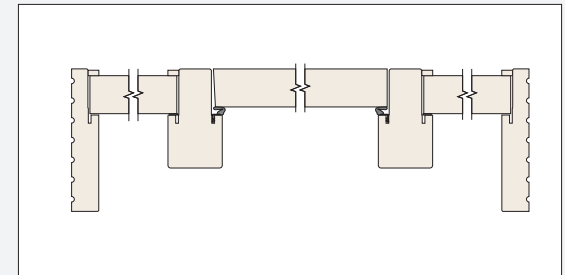

Double Rabbet Frame with Back-to-Back Mull Post

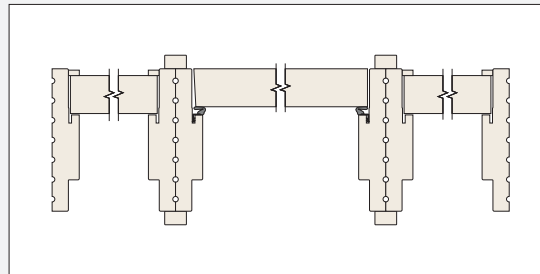

Accommodates screen door applications

Single Rabbet Frame with 6 - 9/16" Uniframe Mull Posts

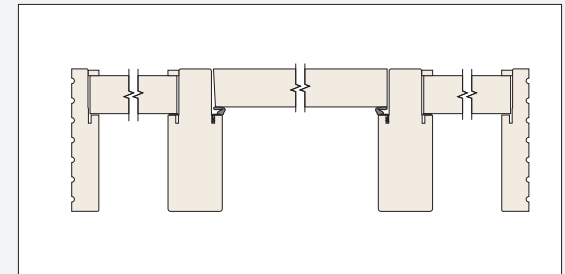

Double rabbet frame, uniframe, and screen doors are available on TruStile Reserve Wood Entry Systems™ only

Wood Species for Reserve Entry Systems

The Reserve Wood Entry System™ elevates the refined elegance of your home with the beauty of stained natural wood. Available in 10 natural wood species with an extensive collection of premium factory stain options.



Consider the Resilient™ Wood Entry System for paint-grade applications.



Mahogany



Genuine Mahogany



Cherry



Douglas Fir (*Vertical Grain*)



Select Alder



Walnut



Plain Sawn White Oak



Quarter Sawn White Oak

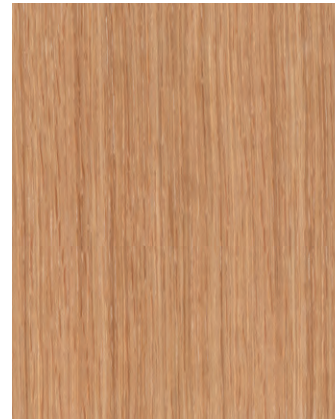

Rift Sawn White Oak



Clear Pine

Paint-Grade Mahogany and Paint-Grade Douglas Fir not shown.

Stain Options

TruStile uses stains from ICA, a leading European finish manufacturer, for factory-finished entry systems. We begin by applying either a clear or tinted base stain with UV inhibitors (unfinished doors also get this base coat). Then a total of five coats of finish are applied. This includes two seal coats and three topcoat layers of finish giving a robust dry film finish thickness. Slight color and sheen differences might occur between interior and exterior finishes.

	Amaretto	Bleached	Cameo	Cappuccino	Caramel	Champagne	Cinnamon	Ebony	Espresso	Grey Mist	Hazelnut	Honey	Nutmeg	Slate	White Haze
Mahogany															
Cherry															
Clear Pine															
Douglas Fir															
Select Alder															
Walnut															
White Oak															

White oak is available as rift sawn, plain sawn or quarter sawn. Plain sawn white oak shown above.

The color of the finish can vary depending on the color of the wood, lighting on the job site, and natural exposure to oxidation and sunlight. To get the best example of the stain color on a specific species, please visit your TruStile dealer.

Hinge Options

Entry systems include 4-1/2" x 4-1/2" TruStile ball-bearing hinges; available in 11 finish options.

Emtek® and Baldwin® hinges can be specified and are available in 5" x 5" size and solid brass.

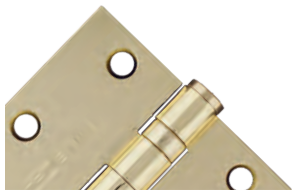

US3 Bright Brass



US19 Flat Black



US5 Antique Brass



US4 Satin Brass



US10A Antique Bronze



10B Oil-Rubbed Bronze



US14 Polished Nickel



US15 Satin Nickel



US15A Antique Nickel



US26 Polished Chrome



US26D Satin Chrome

Sill Options

Choose from the sill options below to complete your entry system.

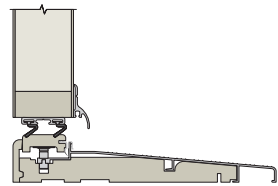

Oak Adjustable

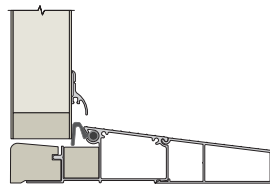

Hydosill

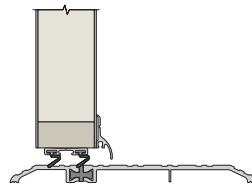

ADA

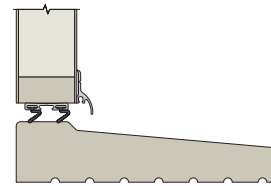

Solid Wood

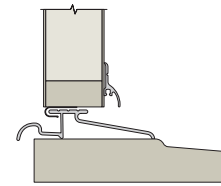

Solid Wood with
Brass Interlock*

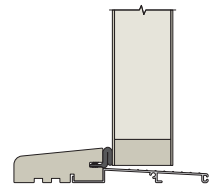

Wood Outswing

Solid wood sills available in genuine mahogany and plain sawn white oak.

** Only available on TruStile Reserve Entry Systems™.*

Insulated Glass Options

Complete your grand entrance with one of our many insulated glass options, including LoE and several decorative patterns.



Clear (LoE 272)*

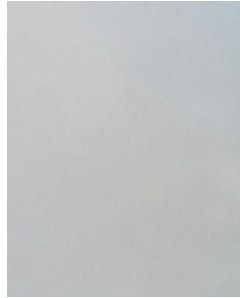

Frosted

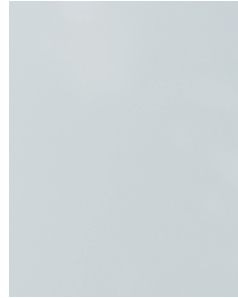

White Lami

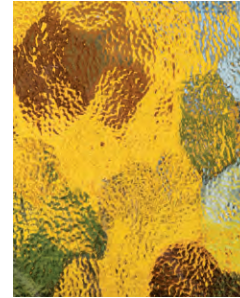

Aqualite



Bevel



Single Glue Chip



Obscure



Rain

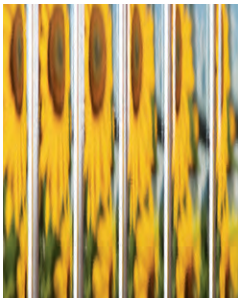

English Reeded

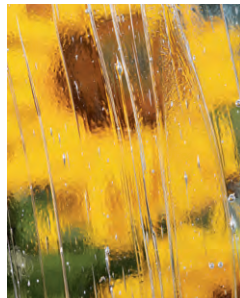

Wavy Seedy (Glacier)

* Clear glass also available as LoE 366, LoE 340, LoE 180, Low Iron and Clear Lami.

Multipoint Lock Option

TruStile offers an automatic locking system from GU-Security which is required for certain warranty coverage.

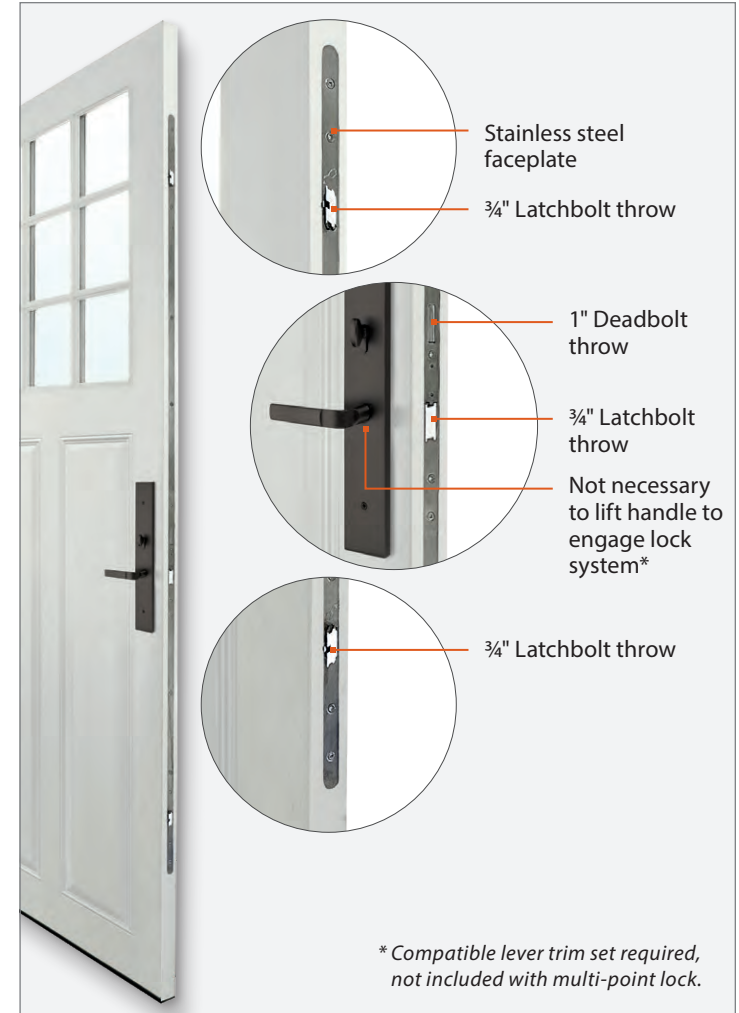

* Compatible lever trim set required, not included with multi-point lock.



See our website for details.
www.trustile.com/multipoint

Comparison of Resilient and Reserve Wood Entry Systems

	Resilient Wood Entry Systems™ with Reduced Overhang	Resilient Wood Entry Systems™ with No Overhang Required	Reserve Wood Entry Systems™ Standard Overhang Required
Door Styles	Over 500 standard door styles	Over 500 standard door styles	Over 500 standard door styles
Maximum Door Size			
Single	Flush Door Styles	47" × 118"	48" × 120"
	Stile & Rail Door Styles	48" × 118"	
Pairs	Flush Door Styles	94" × 118"	96" × 120"
	Stile & Rail Door Styles	96" × 118"	
System Layouts	Most options available	ES101 and ES201 only	All options available
Finish	Painted, user applied	Painted, user applied	Factory prime, stained finish or user applied
Overhang Requirements	Reduced overhang requirements*	No overhang requirements*	Standard overhang requirements*
Application	Residential Not Available for Commercial	Residential Not Available for Commercial	Residential Not Available for Commercial
Limited Warranty	10 year**	10 year**	5 year factory primed or finished; 3 year unfinished**
Maintenance	Painted finish should be inspected annually and re-applied as needed	Painted finish should be inspected annually and re-applied as needed	Top coat finish should be inspected annually and re-applied as needed
Dark Finishes / Paint	Warrantied when ordered with factory multi-point lock	Warrantied when ordered with factory multi-point lock	Warrantied when ordered with factory multi-point lock
Wood Screen / Storm Door	Not available	Not available	Available
Sills	Five different sill options available	Hydosill™	Six different sill options available
Multipoint Lock	GU-Secury Automatic multipoint lock available	GU-Secury Automatic multipoint lock required for pairs	GU-Secury Automatic multipoint lock available

* Refer to TruStile Resilient limited warranty for overhang requirements

** Additional requirements may apply, please refer to TruStile warranty

Industry-Leading Warranty Coverage

TruStile Wood Entry Systems come backed with industry-leading warranty coverage. Door systems that are factory finished by TruStile are warranted to be free from manufacturing defects for 5 years from date of purchase for the Reserve Wood Entry System™ and 10 years from date of purchase for the Resilient Wood Entry System™ depending on application and specifications. Door systems purchased raw and unfinished are warranted to be free from manufacturing defects for 3 years from date of purchase. Due to its aging characteristics, Alder door systems are warranted for 1 year from date of purchase.

Please see www.trustile.com/warranties for specific detail warranty information for each product.

Requirements for Warranty Coverage

Your TruStile Entry Door should be viewed as a piece of well-engineered fine furniture. Careful steps have been taken to design the product to perform in proper exterior openings. However, finishes and natural wood both weather and break down over time. This weathering process increases with greater exposure to the elements. TruStile Wood Entry systems, like those sold by other manufacturers, require proper overhang protection to meet warranty requirements (see diagram below for details). Proper overhang helps to protect both the finish and the natural wood from moisture and UV damage. Even with proper overhang, the topcoat of any stained natural wood door must be inspected annually and reapplied during early signs of fading. Maintaining the topcoat will maximize the life of your natural wood door and is also required to maintain TruStile warranty coverage.

Overhang Requirements

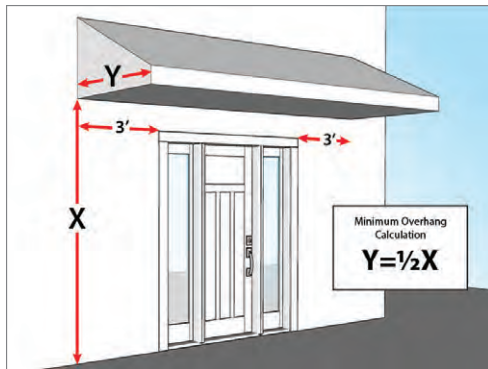

Standard Overhang

Required for Reserve Wood Entry System™ warranty coverage

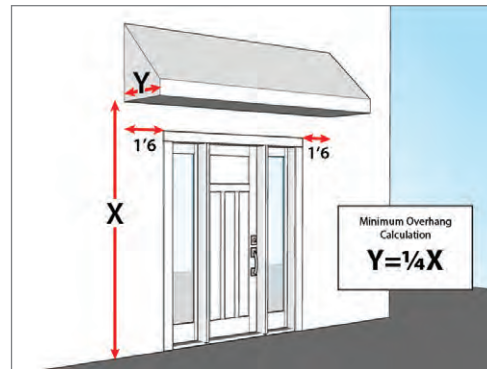

Reduced Overhang

Required for warranty coverage on:

- Resilient Wood Entry Systems with sidelites and/or transoms
- Resilient single and pair units with oak adjustable sill
- Resilient pair units without multi-point locks

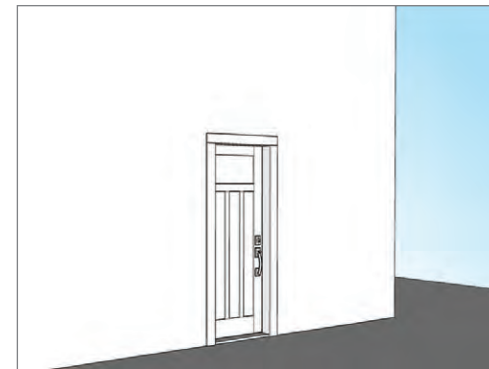

No Overhang Required

Warranty coverage available for Resilient single and pair units meeting the following:

- Hydrosill™ required
- 3'6" × 8'0" maximum single door width
- 6'0" × 8'0" maximum pair width
- Multi-point lock required for no overhang coverage on pairs

Design Tools

Design, Configure and Visualize Your Projects



Door Visualizer

Imagine the possibilities for your home with the TruStile Door Visualizer. Customize your door's style and materials and see changes in real-time.

Share a link to your configured door with others or download a PDF tear sheet, high resolution image or 3D model for use in modeling programs.



www.trustile.com/visualizer

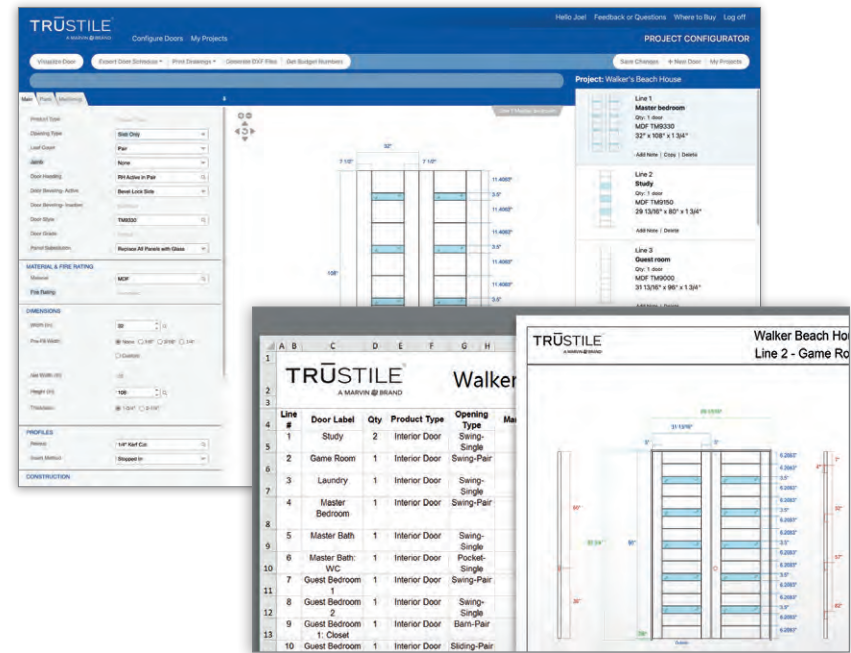

Project Configurator

Design your own door package. Specify the height, width and location of all components within a door and save to a project.

Project Configurator projects can be exported as a door schedule that opens directly in Microsoft® Excel, as a PDF of drawings or CAD models to import directly into your plans.



www.trustile.com/configurator



See page 45 for product specs.

TRŪSTILE[®]
A MARVIN  BRAND

TruStile Doors, LLC
1111 East 71st Avenue
Denver, CO 80229
888.286.3931

