





Contents

TruStile Overview.....	3
Selection Guide.....	9
Architectural Styles.....	11
Material Options.....	61
Design Options.....	78
Commercial Applications.....	81
Sustainability.....	85
Fire Rated Doors.....	87
Sound Doors.....	89
Exterior Doors.....	91
Door Collections.....	93
Door Design Tool.....	136

Above: TMIR5000 door in Quarter Sawn White Oak with Grey Mist stain and ½" Bright Stainless Steel inlays.

Left: TMIR5000 door in MDF with ¼" Kerf Cut reveal



TMUN5000 sliding doors in Quarter Sawn White Oak with Grey Mist finish, Square Stick (SS) sticking and Clear glass.

Premium Architectural Doors

There was a time when doors were appreciated for their architectural value, gracing the openings of homes and embodying the principles of their design periods.

At TruStile, we miss those days. We are committed to partnering with architects, home builders and homeowners, to revive the rich tradition of building high quality, architecturally correct doors with a range of customization options to fit your preferences and your home's unique character.

Visualize the TruStile® Difference

All too often, doors are an overlooked design element — even in high-end custom homes that include an otherwise impressive selection of amenities and upgrades.

Other manufacturers have focused on value-engineering doors, thus diminishing their structural and design integrity. However, the visual impact of high-quality architectural doors is dramatic.

TM13000 in Cherry with clear coat finish and 1/4" Kerf Cut reveal

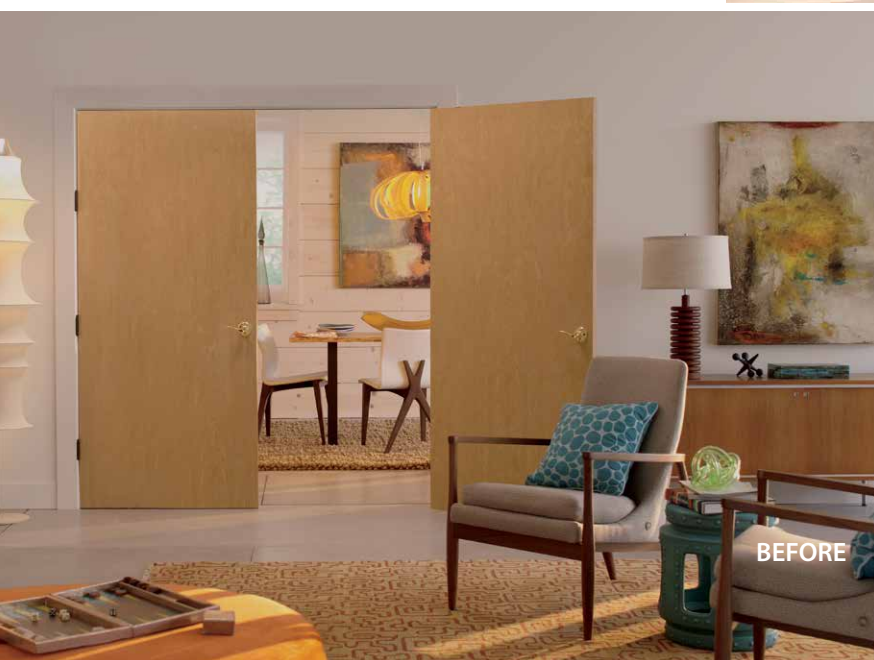

BEFORE

AFTER



TS2060 in MDF with Cove (CV) applied moulding and Flat (C) panel

The Architecturally Correct Door

TruStile doors are built with solid construction, engineered to last. We wouldn't think of stamping out a hollow core door. Each TruStile door is made to order with perfectly proportioned components, created individually to ensure that every door is architecturally correct, regardless of size.

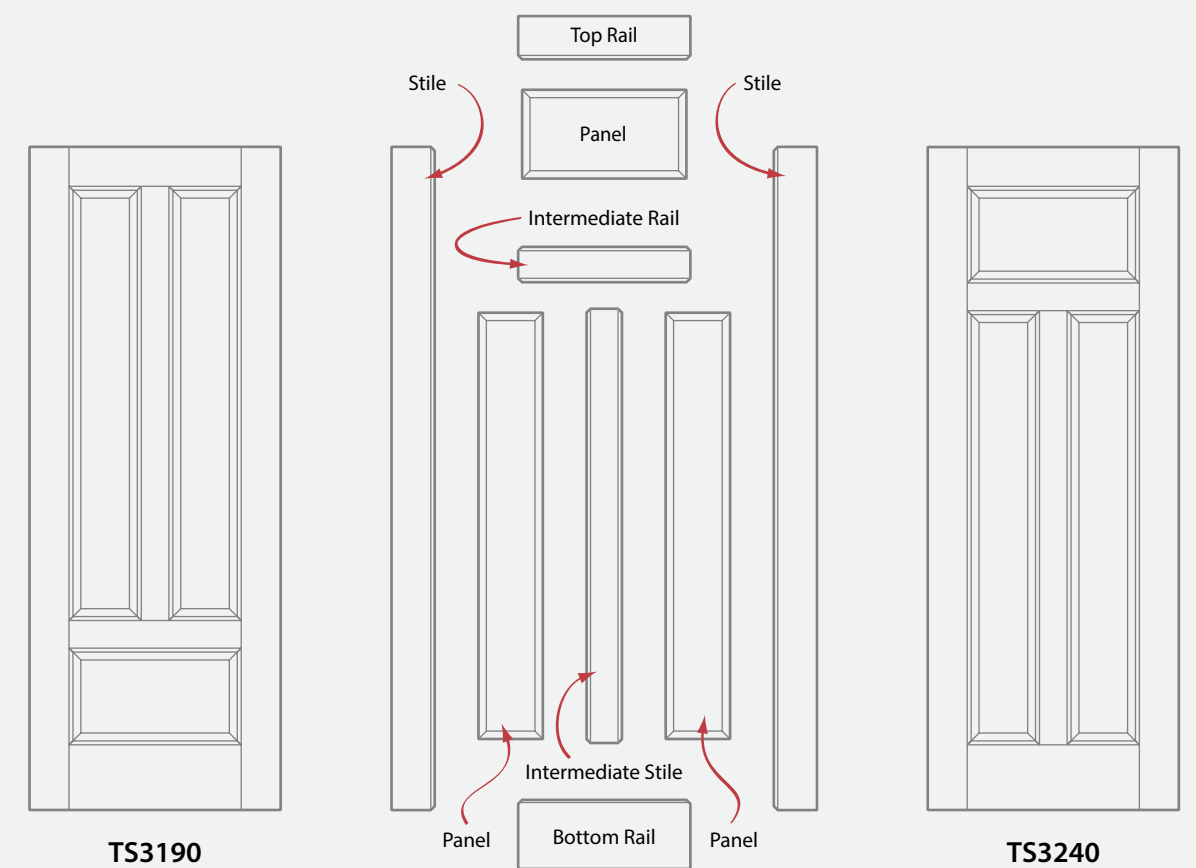

All Doors Are Not Created Equal.

The figure illustrates the timeless advantage of TruStile's authentic stile and rail construction. All door components can be customized and combined to create the style you desire, while the construction method gives each door crisp, architecturally correct lines.

TruStile Selection Guide

5 Steps to Designing Your Perfect Door

To guide your style choices, consider the recommendations in the Architectural Styles section on page 11.



TS5080 pocket door in Plain Sawn White Oak with Grey Mist finish, Square Stick (SS) sticking and Dash glass

1

Door Style

Choose from over 500 door styles to match your home's architecture.



2

Material

Select MDF for painted applications or choose from 20 wood species.

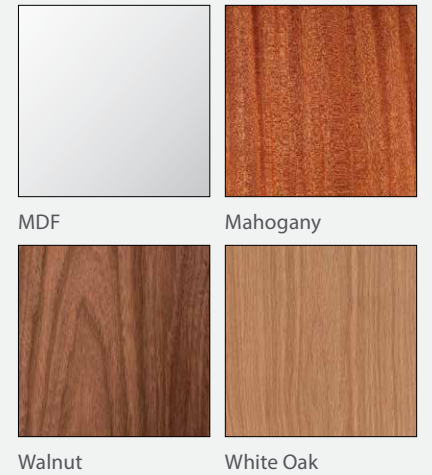

3

Profile Options

Refine your design with the widest selection of profile options to match your desired style.

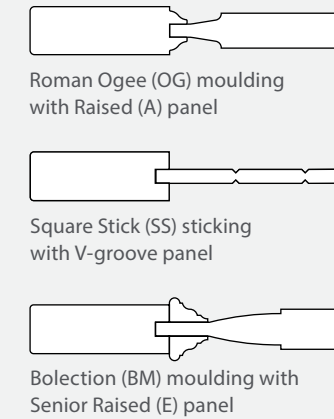

4

Decorative Inserts

Consider exchanging a panel for a unique material insert—glass, resin, leather or metal.

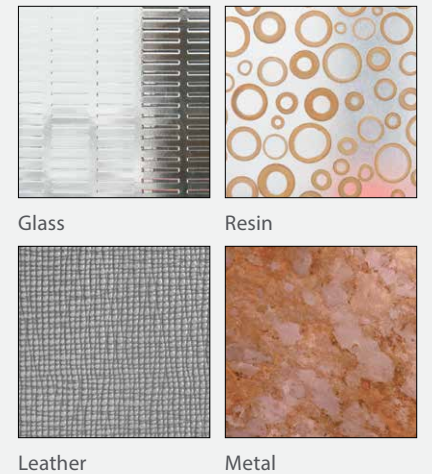

5

Design Options

Further customize your doors with unique options such as a barn door or common arch pair.

See page 78 for more ideas.

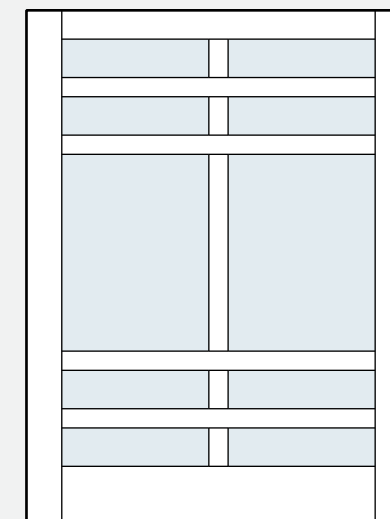

TS5080 Barn Door with Glass Panels



TS4150 Common Arch Pair



TM13340 doors in Walnut with Cappuccino stain and Frosted glass inserts.

Find Your Architectural Style

Where do you begin to choose the right door design for your home? TruStile's Authentic Designs® makes the selection process fun and easy. With a range of materials and options for 12 popular architectural styles, TruStile provides the widest range of on the market today.

Read on and be inspired with just a few of our tantalizing options for distinctive, remarkable doors.

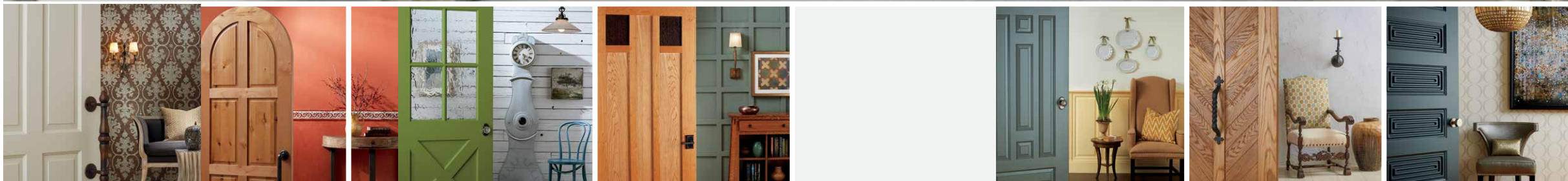



ART DECO

An eclectic style decorated with geometric shapes and accents of metal and glass.

- The Art Deco design style began after WWI and flourished in the 1930s and 1940s, waning after WWII.
- While there are no distinct guiding design principles of Art Deco, there are stylistic elements connected by common themes: the decorative, the commercial, the fashionable and the symbolic.
- The TruStile Art Deco door styles combine modern European design ideas introduced in France with the romance of 1930s Hollywood.

TMB6120 in MDF with Bevel profile

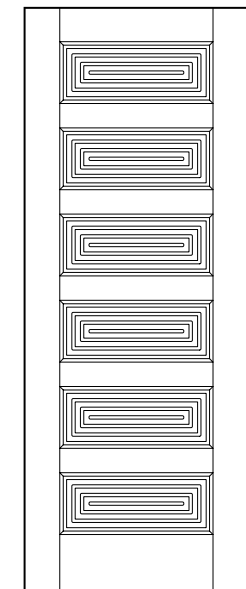

TMB6120 in MDF with Bevel Tambour profile

ART DECO

Find the ideal expression of the streamlined and sophisticated art deco style right here.

RECOMMENDED DOOR STYLES

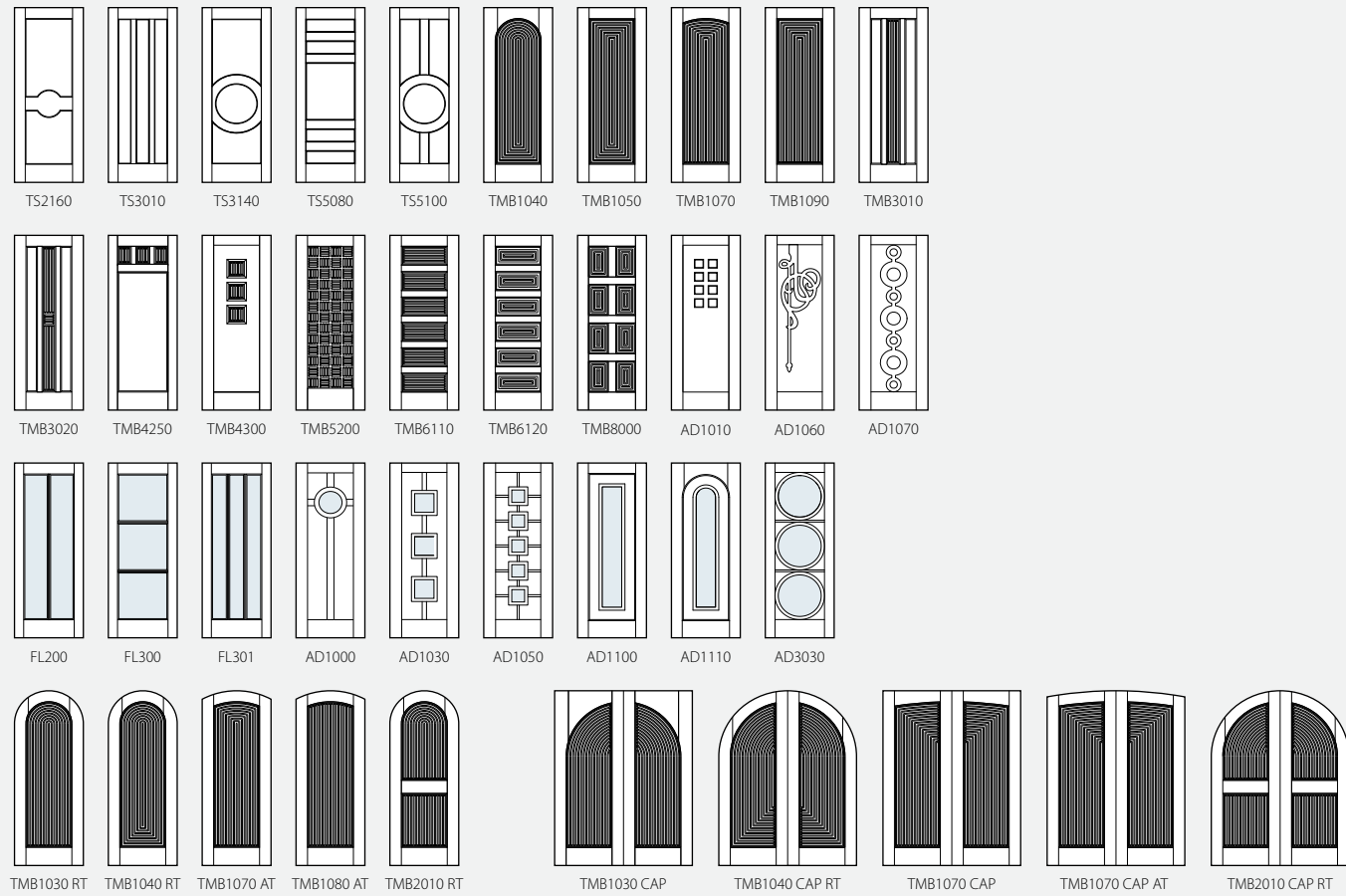

PROFILE SUGGESTIONS

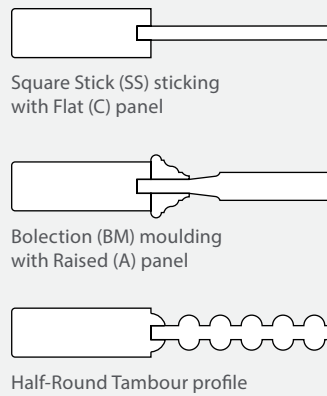

WOOD SPECIES SUGGESTIONS

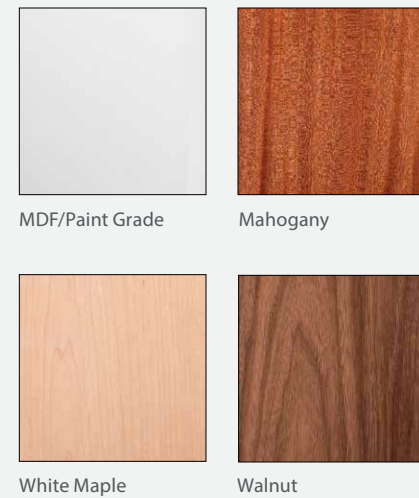

INSERT SUGGESTIONS



AD1070 in MDF



COLONIAL

An authentically American style characterized by stately, historic design features.

- A variety of architectural styles developed throughout the 18th and 19th centuries as the English, Dutch, Germans and French settled in America.
- Characterized by symmetry and balance, formal surface design and ornamentation with special attention to doors and windows.
- Authentic TruStile doors from the Colonial collection provide classic grace and elegance along with an early American sensibility.

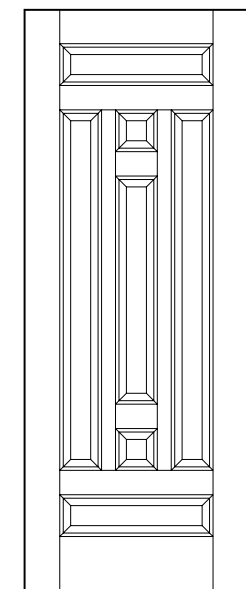

TS7010 in MDF with Roman Ogee (OG) sticking and Raised (A) panel

COLONIAL

Find the distinct, formal design for your colonial home that emphasizes symmetry and balance right here.

RECOMMENDED DOOR STYLES

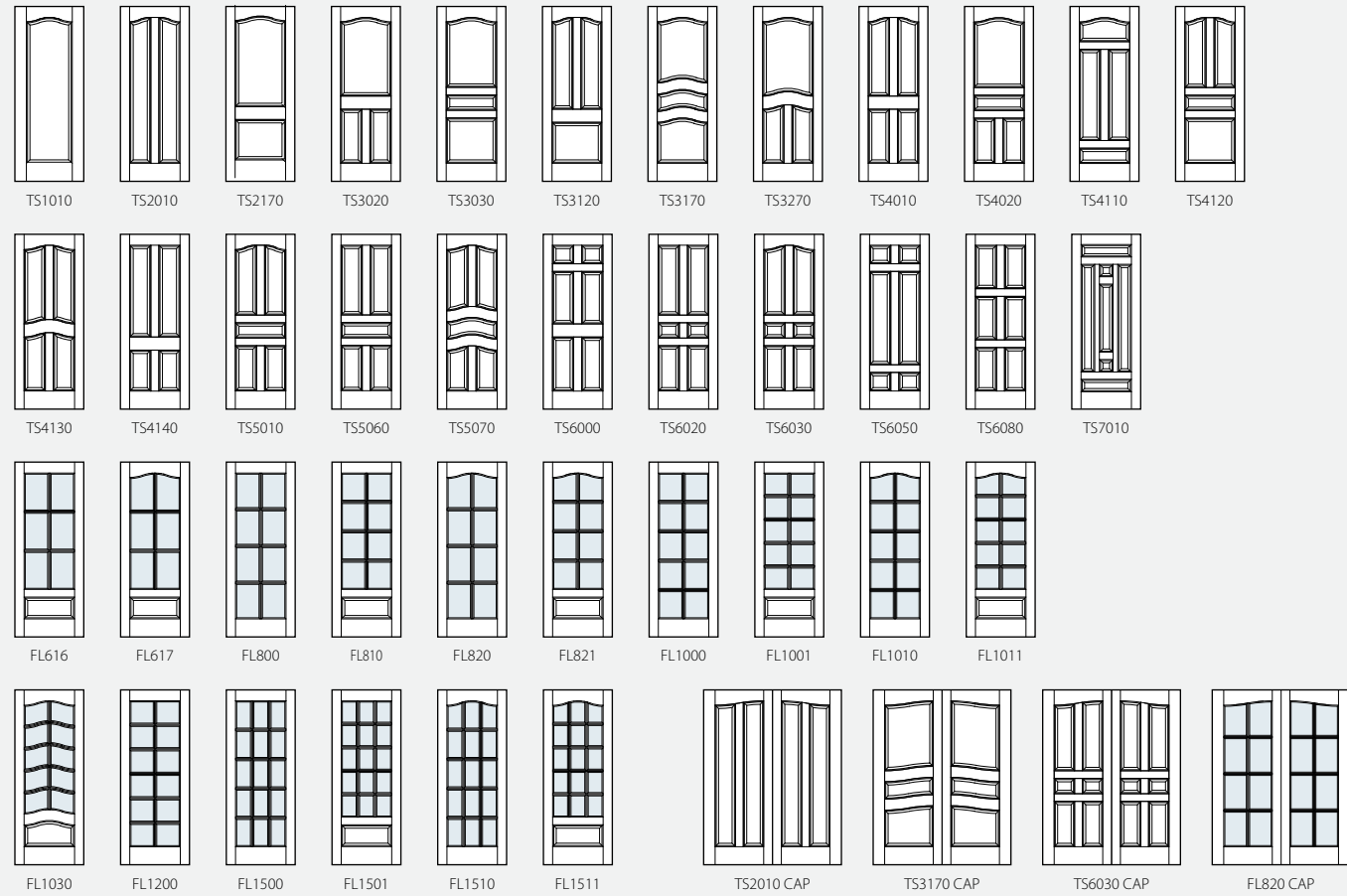

PROFILE SUGGESTIONS



Roman Ogee (OG) sticking with Scoop (B) panel



Cove & Bead (CB) sticking with Scoop (B) panel



Quarter Bead (QB) sticking with Raised (A) panel

WOOD SPECIES SUGGESTIONS



MDF/Paint Grade



Cherry



Mahogany

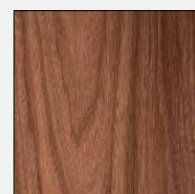

Walnut

INSERT SUGGESTIONS



Bevel Glass



Seedy Wash Glass



Oak Leather

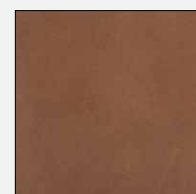

Pampas Leather



TS4010 in Walnut with Roman Ogee (OG) sticking and Scoop (B) panel



CONTEMPORARY

A forward-looking style that is uniquely yours.

- Contemporary architecture reflects the current building style of today.
- Characteristics of contemporary homes are unique or odd shaped frames, open floor plans, oversized windows, connected indoor and outdoor spaces and warm interiors.
- TruStile's Contemporary series is an eclectic collection that borrows ideas from different eras. Popular elements are clean lines and the use of natural, sustainable materials.

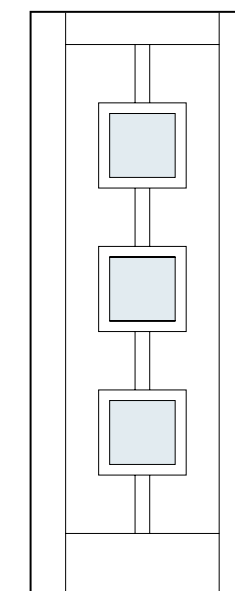

AD1030 in LVL with Square Stick (SS) sticking, Flat (C) panel and Ginkgo Thatch resin

CONTEMPORARY

Find the ideal expression of what contemporary design means to you.

RECOMMENDED DOOR STYLES



PROFILE SUGGESTIONS



1/8" Radius reveal



Quarter Bead (QB) sticking with Raised (A) panel

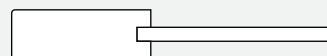

Square Stick (SS) sticking with Flat (C) panel

WOOD SPECIES SUGGESTIONS



MDF/Paint Grade



Walnut



Bamboo



LVL

INSERT SUGGESTIONS



Brush Brass Metal

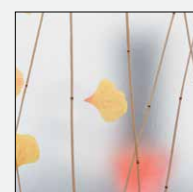

Gingko Thatch Resin

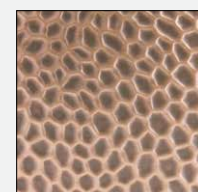

White Lami Glass

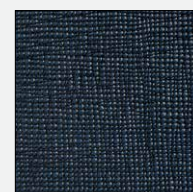

Newest Navy Leather



TM9000 in MDF with 1/4" Kerf Cut reveal



COTTAGE

A comfortable style that reflects architectural simplicity.

- The American cottage style of architecture was inspired by the English countryside and features a cozy, almost storybook character.
- Characteristics include steep roofs, arched doors and casement windows. A variety of natural materials can be used ranging from wood siding, stone, shingles and copper.
- TruStile's Cottage series represents historically accurate door styles in both panel and glass configurations, as well as updated interpretations of the historic designs.

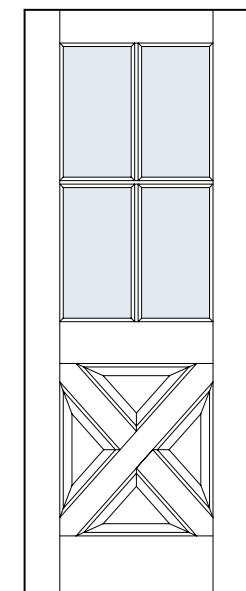

PL404 in MDF with Wave glass, Roman Ogee (OG) sticking and Flat (C) panel

COTTAGE

Find the natural expression of the simple and charming cottage style right here.

RECOMMENDED DOOR STYLES

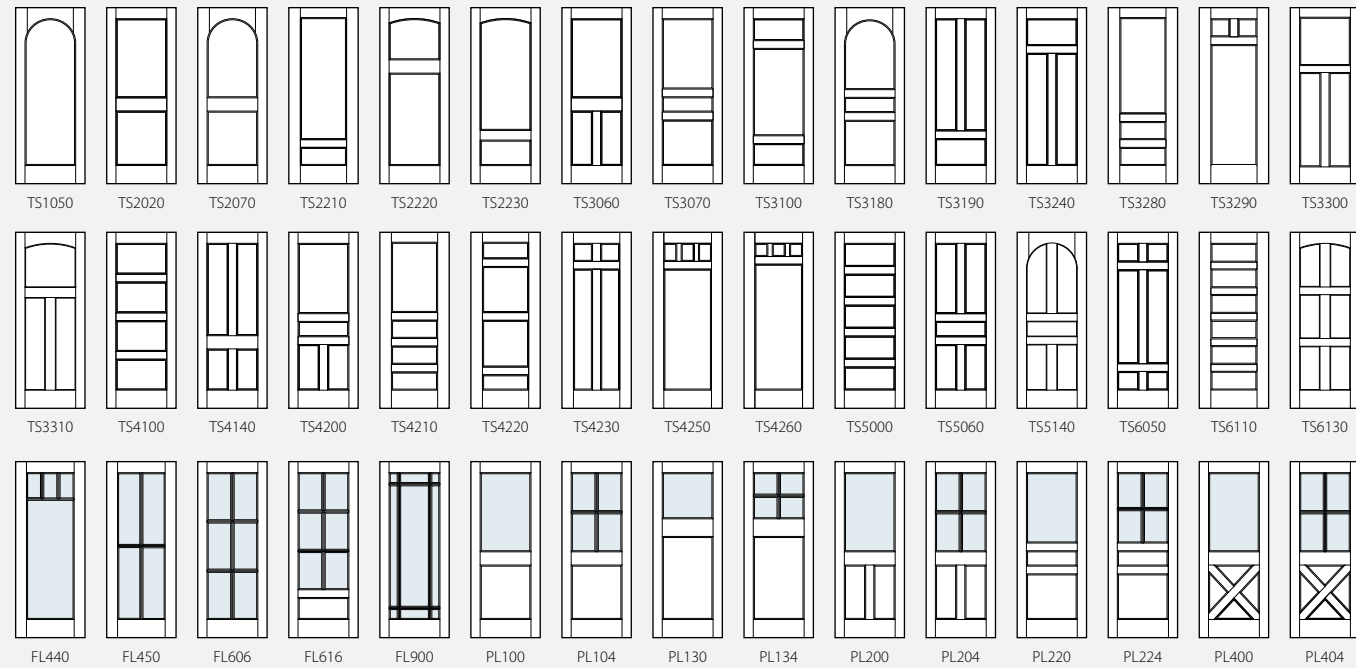

PROFILE SUGGESTIONS



Quarter Bead (QB) sticking with Flat (C) panel



Quarter Round (QR) sticking with Raised (A) panel

WOOD SPECIES SUGGESTIONS



MDF/Paint Grade



Select Alder



Clear Pine

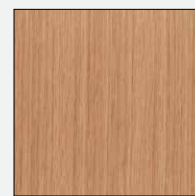

White Oak
(Rift Sawn)

INSERT SUGGESTIONS



Arctic Glass



Clear Leaf Glass



Wave Glass



Patina Monet Metal



TS3100 in MDF with Quarter Bead (QB) sticking and Flat (C) panel



CRAFTSMAN

A simple style focused on natural materials and an attention to period details.

- The American Craftsman style emerged from the English Arts & Crafts movement of the late 1800s and was a reaction to the overly decorative Victorian era and a rejection of mechanization.
- Emphasizes simplicity of form, originality and local natural materials.
- Simplicity and quality workmanship define the TruStile Craftsman door collection.

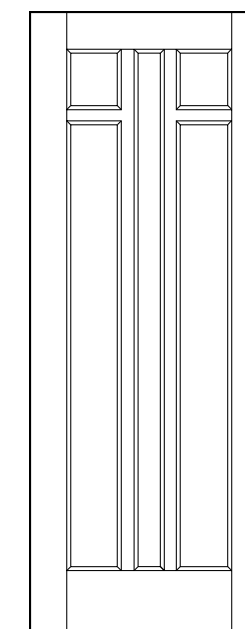

TS5120 in Cherry with Wenge inserts, Square Stick (SS) sticking and Flat (C) panel

CRAFTSMAN

Find hand crafted doors that will add an authentic touch to your modern day bungalow right here.

RECOMMENDED DOOR STYLES

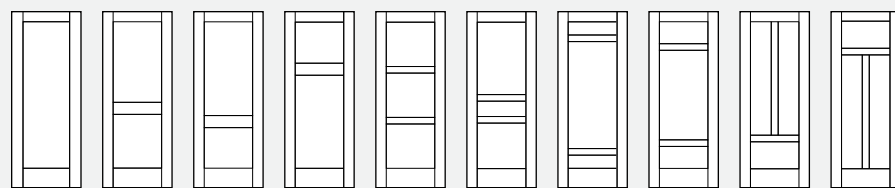

TS1000 TS2020 TS2060 TS2200 TS3000 TS3070 TS3080 TS3100 TS3190 TS3240

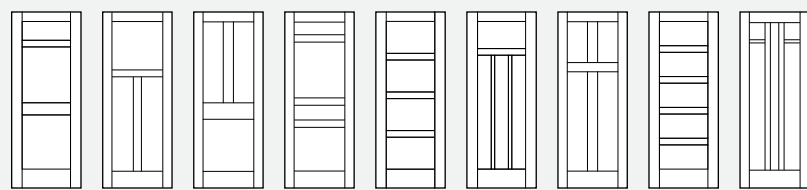

TS3250 TS3300 TS3340 TS4060 TS4100 TS4190 TS4280 TS5000 TS5120

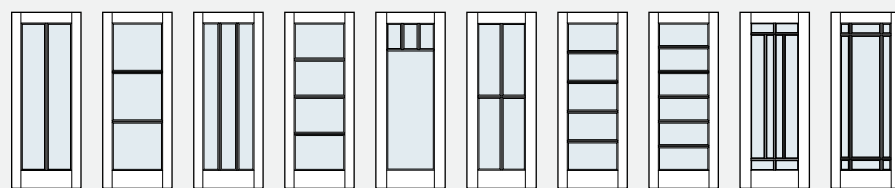

FL200 FL300 FL301 FL400 FL440 FL450 FL500 FL600 FL850 FL900

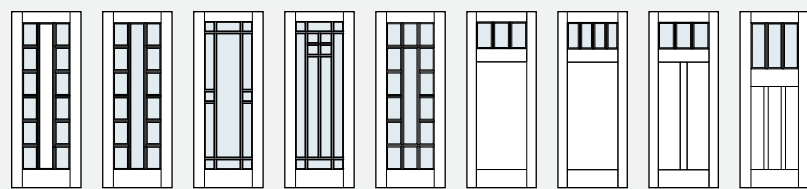

FL1250 FL1300 FL1310 FL1400 FL1540 PL143 PL144 PL243 PL333

PROFILE SUGGESTIONS

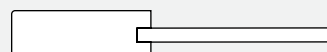

Square Stick (SS) sticking with Flat (C) panel



One Step (OS) sticking with Flat (C) panel

WOOD SPECIES SUGGESTIONS



MDF/Paint Grade

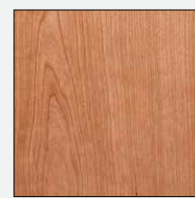

Cherry

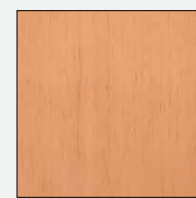

Douglas Fir



White Oak
(Quarter Sawn)

INSERT SUGGESTIONS



Glue Chip Glass



Seedy Wash Glass

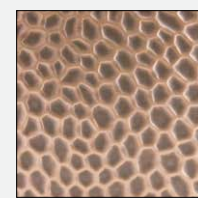

Reptilian Metal

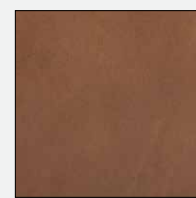

Pampas Leather



TS3300 in MDF with Square Stick (SS) sticking and Flat (C) panel



FRENCH COUNTRY

An eclectic yet decidedly French style that evokes classic European appeal.

- From elaborate Ecole-des-Beaux-Arts inspired Chateaux to stunning estates in Provence, the French Country style includes decorative detailing, organic floral patterns, distressed woodwork and the use of both subdued and vibrant tones.
- Whether your tastes lean toward the formal Chateau style or the relaxed provincial style, TruStile's French Country series will take your design sensibilities back to the high style of French art and architecture.



Arch-top TS3040 (modified lock rail height) in MDF with Roman Ogee (OG) sticking and Senior Raised (E) panel

FRENCH COUNTRY

Art and style that is intrinsically French marries casual charm with understated elegance. Find it here.

RECOMMENDED DOOR STYLES



PROFILE SUGGESTIONS

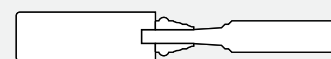

Low Profile Bolection (LP) moulding with Double Hip (D) panel



Roman Ogee (OG) sticking with Senior Raised (E) panel



Roman Ogee (OG) sticking with Raised (A) panel

WOOD SPECIES SUGGESTIONS



MDF/Paint Grade



Knotty Alder



Clear Pine

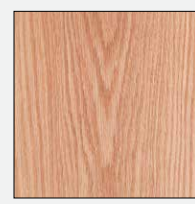

Red Oak
(Plain Sawn)

INSERT SUGGESTIONS



Brushed Glass



Rain Glass

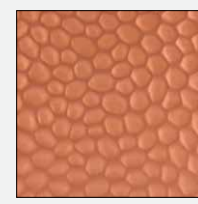

Cobblestone Metal



Shagreen Coudous
Leather



TS2050 in MDF with Low Profile Bolection (LP) moulding and Double Hip (D) panel



MEDITERRANEAN

An enduring trend in American architecture and interior design that expresses a Tuscan sensibility.

- Inspired by the Italian Renaissance, Mediterranean designs appeared in American architecture between the late 1800s and early 1900s. This movement drew heavily on Italian palaces and seaside or country villas.
- Mediterranean details include arched windows and doorways, recessed entryways, red tiled roofs and stuccoed walls.
- TruStile's Mediterranean collection brings the richness and charm of Italian living to your home.

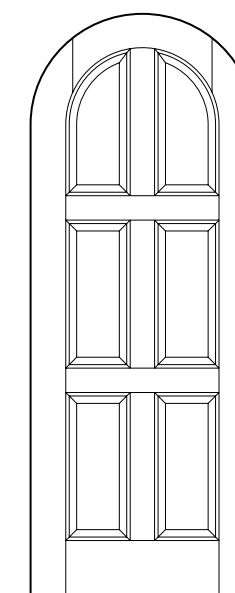

Radius-top TS6090 in Knotty Alder with Square Stick (SS) sticking and Raised (A) panel

MEDITERRANEAN

Find the warm aesthetic of Mediterranean style through this simple yet elegant offering right here.

RECOMMENDED DOOR STYLES

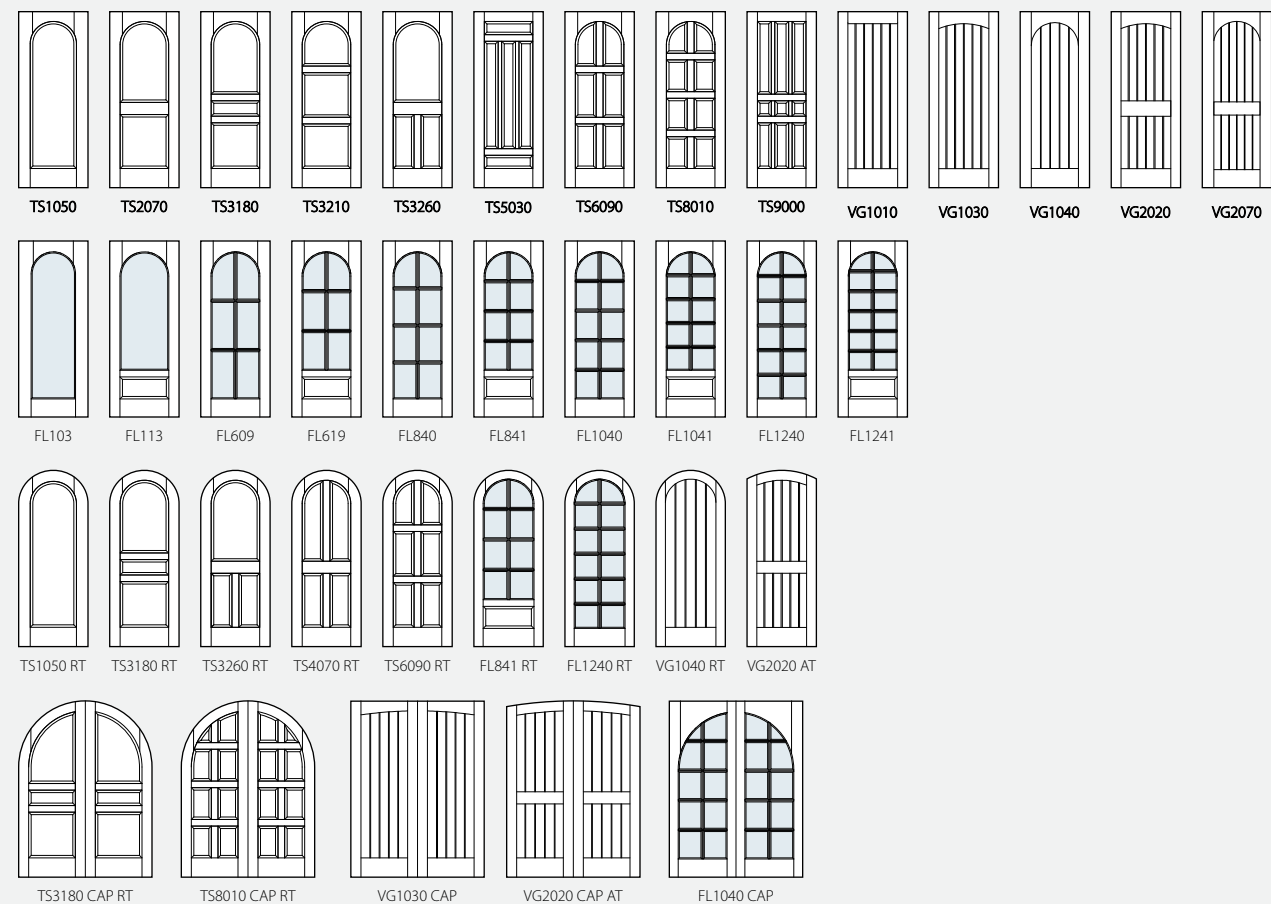

PROFILE SUGGESTIONS

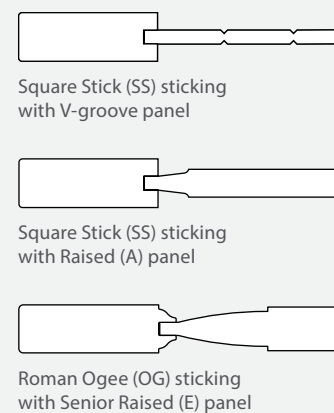

WOOD SPECIES SUGGESTIONS

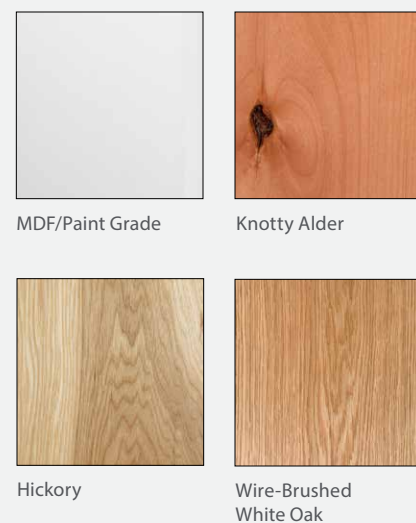

INSERT SUGGESTIONS

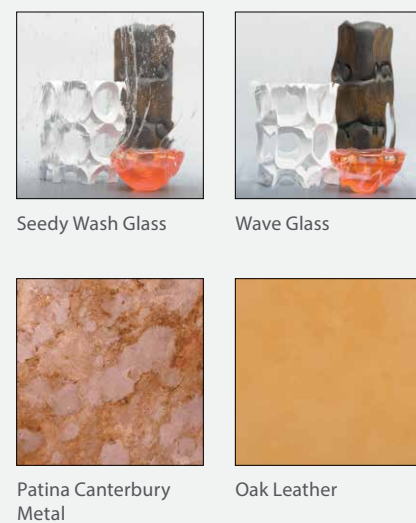

VG1000 plank door in Hickory with Cappuccino stain and wide V groove plank width

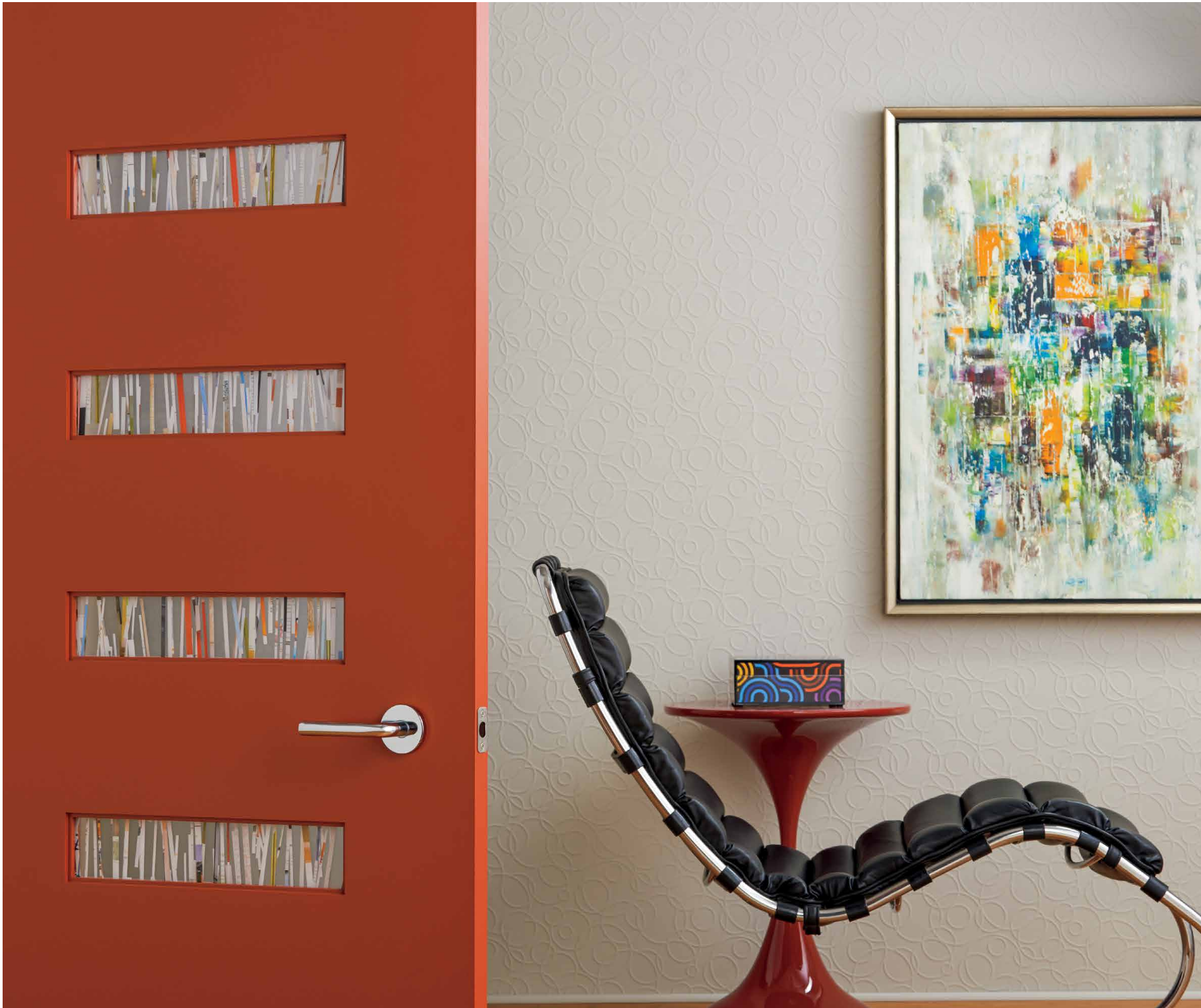

MODERN

Clean strong lines. Bold accents.
Custom design options.

- Early Modern architecture took root in the U.S. in the 1920s and reached its peak in the mid 20th century.
- Characterized by simplification of form, an absence of ornate detail and a belief that “less is more”. Modern style has streamlined horizontal lines and uses industrial materials such as concrete, steel and glass.
- TruStile’s Modern Door Collection is centered around crisp, stacked rails, clean strong lines, oversized stiles, custom design options and bold accents.

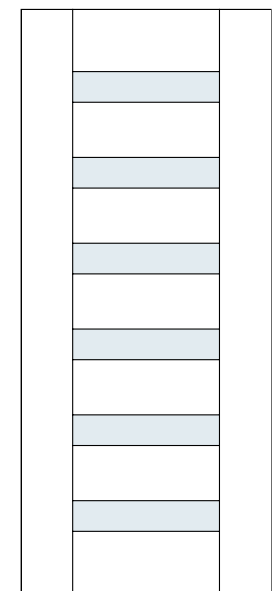

Modified TM6100 in MDF
with One Step (OS) sash
and Paper Cut resin inserts

MODERN

Make a clever design statement before ever entering the room. Find it here.

RECOMMENDED DOOR STYLES



PROFILE SUGGESTIONS



1/8" Radius reveal



1/4" Kerf Cut reveal

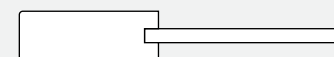

Square Stick (SS) sticking with Flat (C) panel

WOOD SPECIES SUGGESTIONS



MDF/Paint Grade

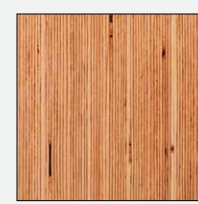

LVL

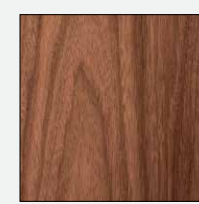

Walnut



White Oak (Plain Sawn)

INSERT SUGGESTIONS



White Lami Glass

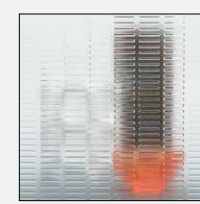

Dash Glass



Connection Envy Resin



Milk & Cookies Leather



TM13340 in Walnut with 1/4" Kerf Cut reveal and White Lami glass



SPANISH COLONIAL

A warm style that exudes a sophisticated design with ornate touches.

- The Spanish Colonial style of architecture was popular in the early 20th century and was embraced in both Florida and California, as well as the southwestern U.S.
- This style is characterized by smooth stucco walls, low pitched roofs, arched entryways and small porches or balconies.
- TruStile's Spanish Colonial series showcases doors with simple lines associated with today's Mission-inspired architecture as well as decorative Spanish Revival door designs.

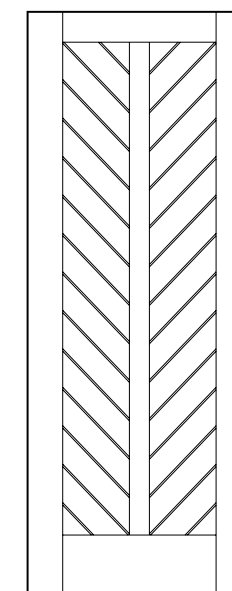

VG2010 in Wire-Brushed White Oak, Square Stick (SS) sticking and V-groove panels

SPANISH COLONIAL

Find the warm expression of the elegant and refined Spanish Colonial style right here.

RECOMMENDED DOOR STYLES



PROFILE SUGGESTIONS



One Step (OS) sticking with Flat (C) panel

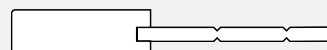

Square Stick (SS) sticking with V-groove panel



Roman Ogee (OG) with Senior Raised (E) panel

WOOD SPECIES SUGGESTIONS



MDF/Paint Grade



Knotty Alder

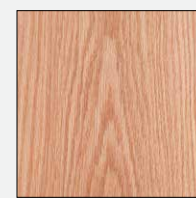

Red Oak

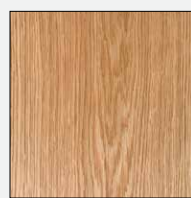

Wire-Brushed White Oak

INSERT SUGGESTIONS

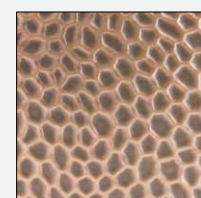

Reptilian Metal

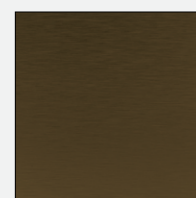

Brushed Bronze Metal



Dashing Old Sterling Leather



Wave Glass



Radius top TS2090 in Red Oak with One Step (OS) sticking and Flat (C) panel



TRADITIONAL

Traditional design often reflects the common sense principles of practicality and functionality.

- Broadly defined, Traditional or vernacular architecture is viewed as a conservative way of building homes to retain the style and beauty of a particular community based on the localized design and historic context.
- On the East Coast, this style is most often associated with Cape Cod, Shingle or Americana styles, while in the Western U.S. the American Ranch style is predominant.
- TruStile's Traditional series reflects the classic and historic design ideas of an earlier time and place.

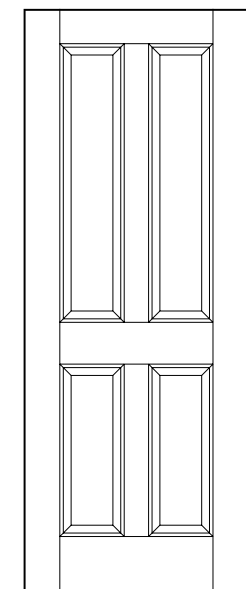

TS4000 in MDF with Traditional (TR) sticking and Raised (A) panel

TRADITIONAL

Bring the charm of Americana or the historic character of the New England Cape to your home with any of these doors.

RECOMMENDED DOOR STYLES

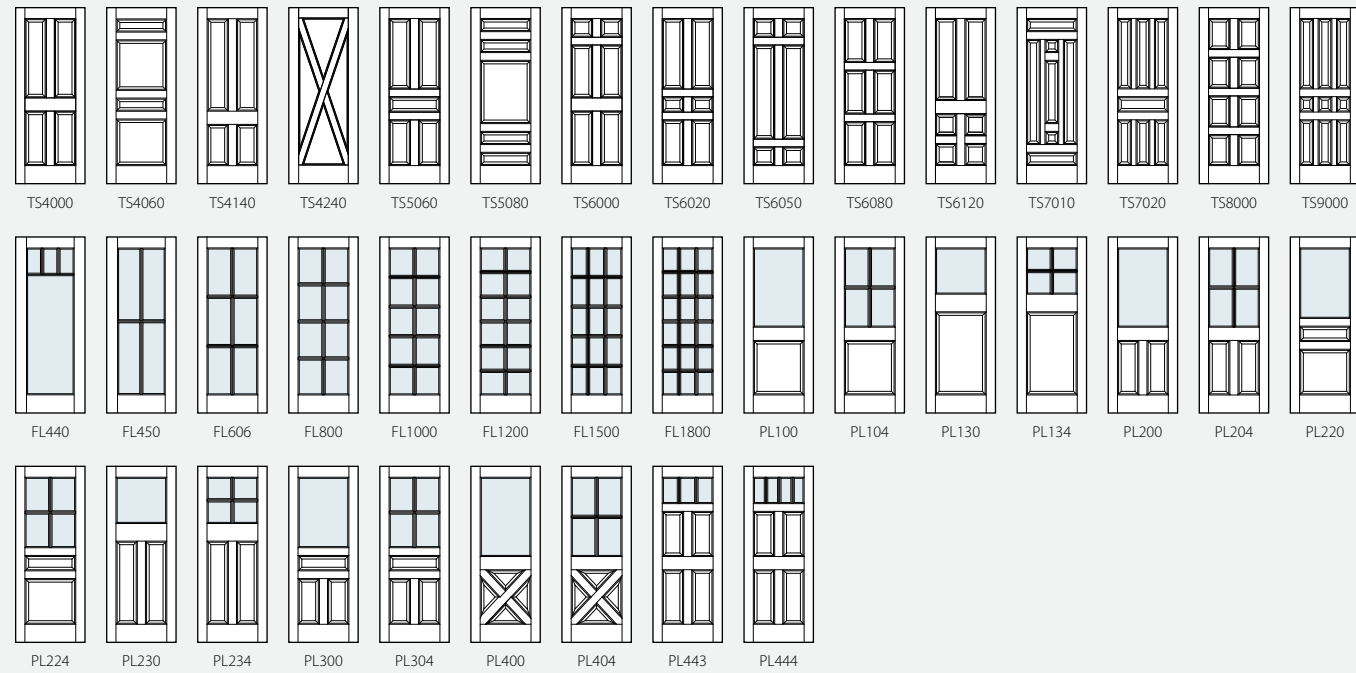

PROFILE SUGGESTIONS



Cove & Bead (CB) sticking with Raised (A) panel



Quarter Bead (QB) sticking with Flat (C) panel



Quarter Round (QR) sticking with Raised (A) panel

WOOD SPECIES SUGGESTIONS



MDF/Paint Grade



Cherry



Mahogany



Poplar

INSERT SUGGESTIONS



Bevel Glass



Clear Leaf Glass

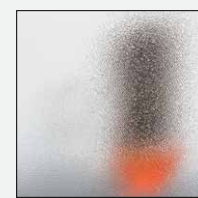

Obscure Glass

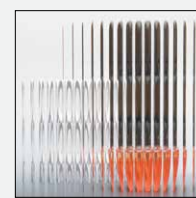

Reeded Glass

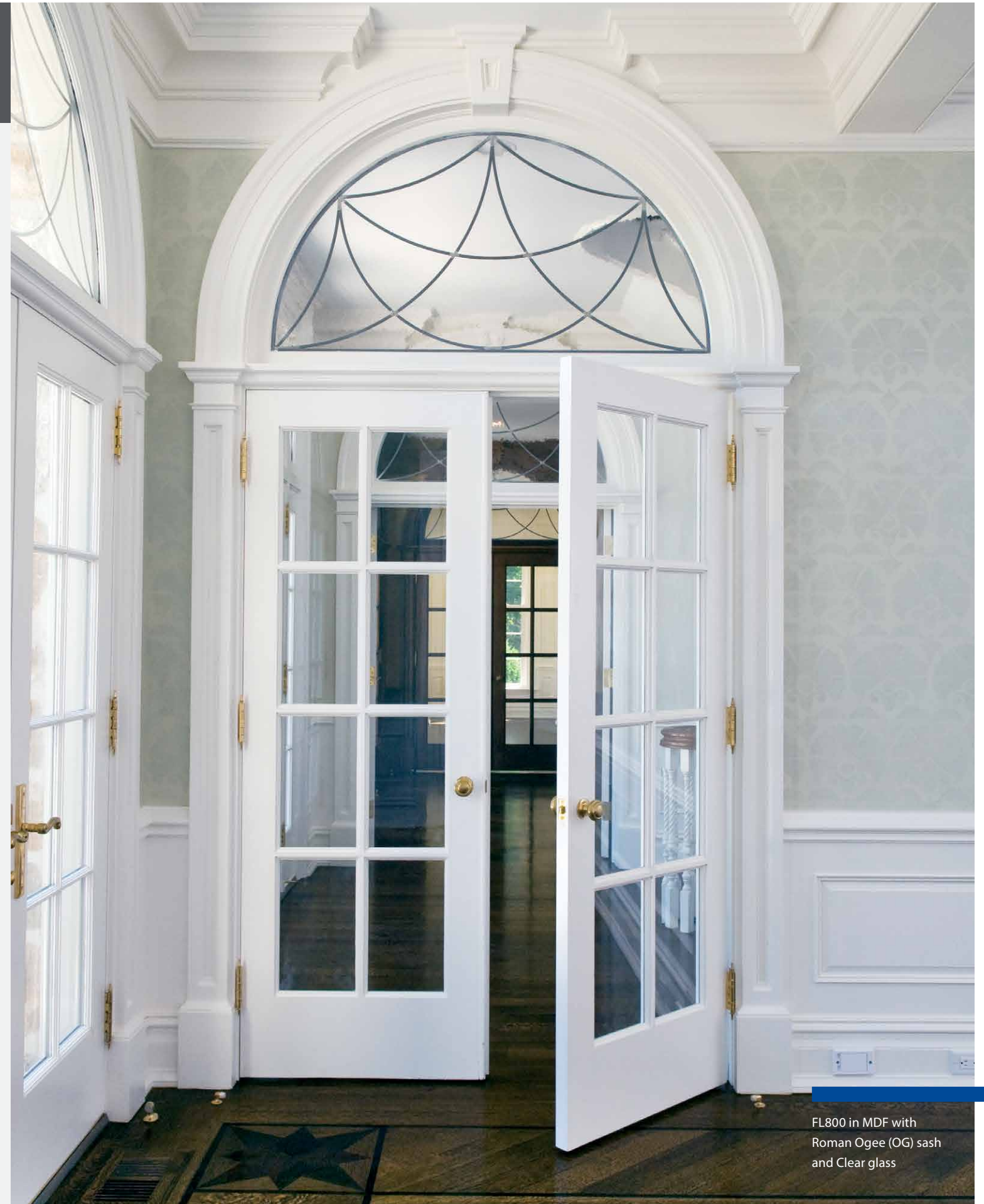

FL800 in MDF with Roman Ogee (OG) sash and Clear glass



TUDOR

Tudor architecture reflects a return to a more conservative and formal aesthetic.

- The Tudor period was a distinct part of the Revivalist period in architectural history.
- The Tudor home features steeply pitched gabled roofs, high chimneys, tall mullioned windows and half-timbering.
- Inspired by English manor homes, the TruStile Tudor series features an assortment of elegant designs and gentle arches.

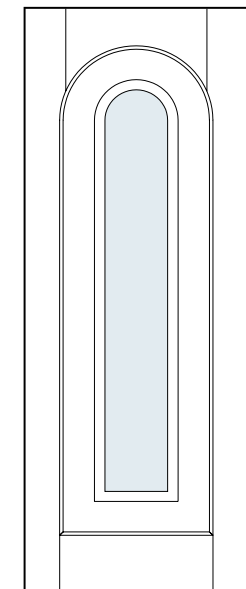

AD1110 in Walnut with Square Stick (SS) sticking, Flat (C) panel and Reeded glass insert

TUDOR

TruStile's Tudor series will bring a touch of English charm to your home. Find it here.

RECOMMENDED DOOR STYLES

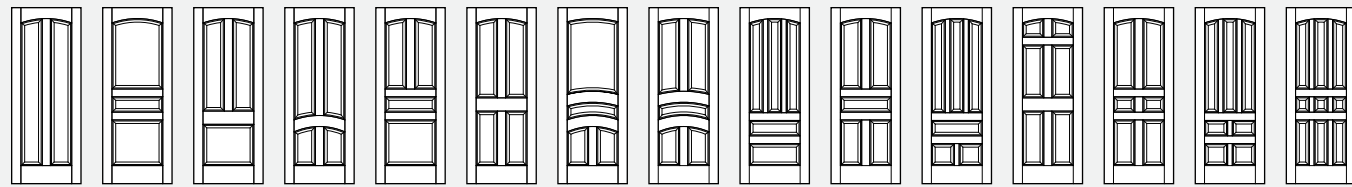

TS2130 TS3050 TS3110 TS4030 TS4040 TS4050 TS4150 TS5020 TS5040 TS5050 TS6040 TS6070 TS6100 TS7000 TS9010

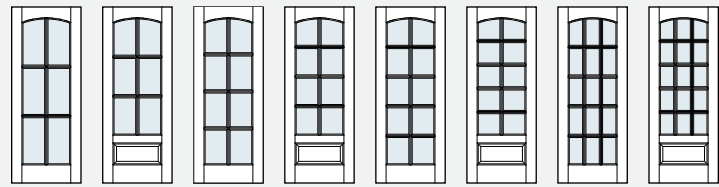

FL608 FL618 FL830 FL831 FL1020 FL1021 FL1520 FL1521

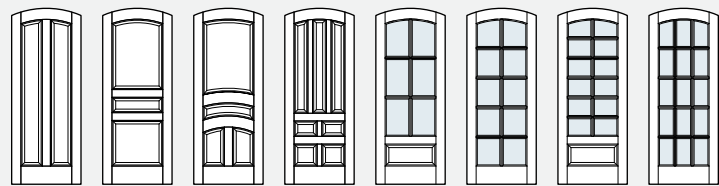

TS2130 AT TS3050 AT TS4150 AT TS7000 AT FL618 AT FL1020 AT FL1520 AT

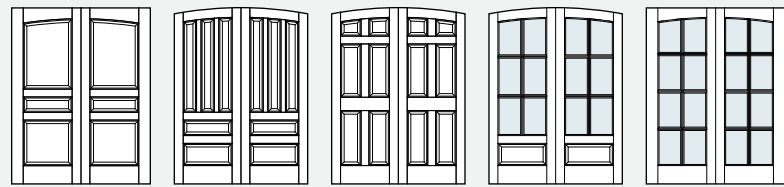

TS3050 CAP TS5040 CAP AT TS6070 CAP AT FL618 CAP AT FL830 CAP

PROFILE SUGGESTIONS



Cove & Bead (CB) sticking with Double Hip (D) panel



Low Profile Belection (LP) moulding with Raised (A) panel



Roman Ogee (OG) sticking with Raised (A) panel

WOOD SPECIES SUGGESTIONS



MDF/Paint Grade



Select Alder



Mahogany

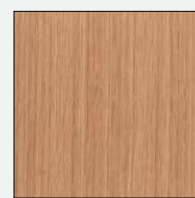

White Oak
(Rift Sawn)

INSERT SUGGESTIONS



Glue Chip Glass

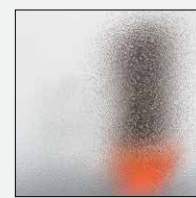

Obscure Glass



Dashing Old
Sterling Leather

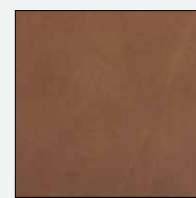

Pampas Leather



Arch top TS3050 in MDF with Roman Ogee (OG) sticking and Raised (A) panel



VICTORIAN

Where unconventional ideas took root and elaborate styles came to light.

- The Victorian era of architecture reigned from the 1830s until the beginning of the 20th century and was known as a period of romanticism.
- Ornamentation such as gingerbread detailing or Victorian lace is frequently used. Roof lines tend to be accented with hipped gables, towers and dormers.
- The ornate nature of the TruStile Victorian door line effectively reproduces this historic time period within your home.

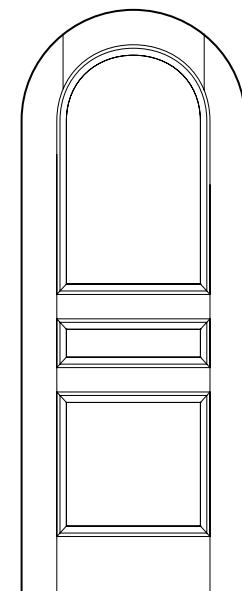

Radius-top modified TS3180 in White Oak with Bolection (BM) moulding and Raised (A) panel

VICTORIAN

Romantic expression and imagination are emphasized in the Victorian style. Find it here.

RECOMMENDED DOOR STYLES



PROFILE SUGGESTIONS

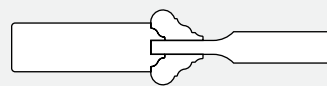

Big Bolection (BB) moulding with Scoop (B) panel

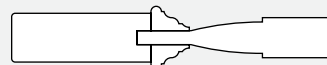

Bolection (BM) moulding with Senior Raised (E) panel

WOOD SPECIES SUGGESTIONS



MDF/Paint Grade



Mahogany



Maple

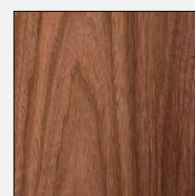

Walnut

INSERT SUGGESTIONS



Bevel Glass

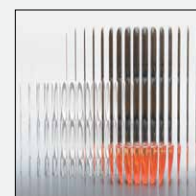

Reeded Glass



Seedy Wash Glass



Croc Black Leather



TS4070 Radius top in MDF with Roman Ogee (OG) sticking and Raised (A) panel



Left: Modified TS3280 in MDF with Square Stick (SS) sticking and custom etched glass. Right: Customized PL143 barn doors.

Material Options

Like furnishings and décor, doors should complement your home's unique architecture and individual style. TruStile Doors provide you with ultimate flexibility, offering unique material options including accents of metal, glass, resin and leather; common arch pairs and built-in mirrors — just to name a few.

TruStile MDF Doors

TruStile MDF Doors provide quality that is unrivalled. Our use of super-refined MDF and meticulous construction methods result in a painted door product that is a cut above the rest.

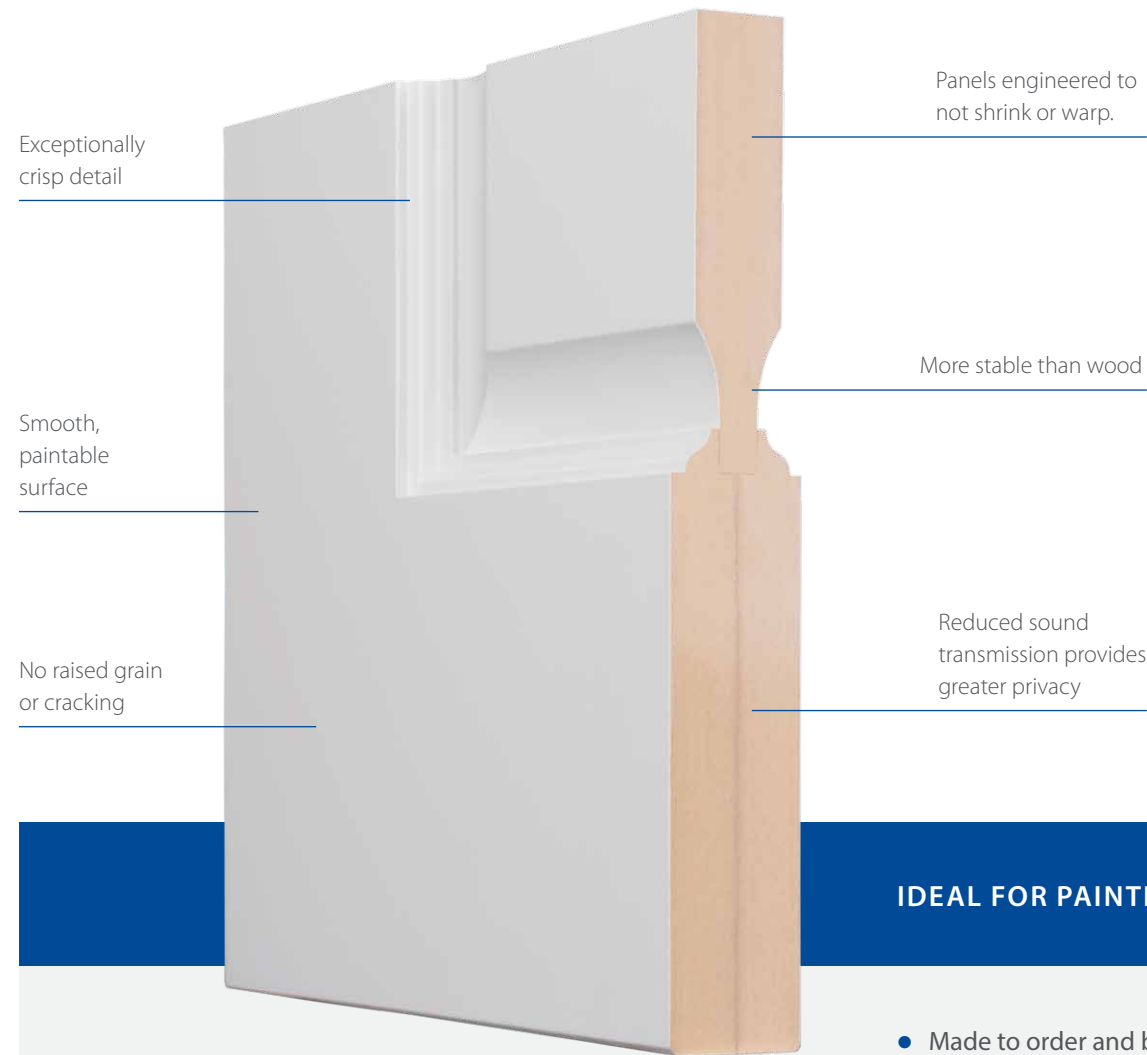

IDEAL FOR PAINTED APPLICATIONS

- Made to order and built to any size and style.
- Built with genuine stile and rail construction — never routed or stamped.
- Made with solid, super-refined MDF that provides a smoother painting surface than pine, poplar or lower-grade MDF alternatives.
- MDF is more stable than natural wood and less susceptible to movement and warping.
- More affordable than wood doors.
- Third party certified by Scientific Certification Systems to contain 69% recycled content, making them ideal for green building.

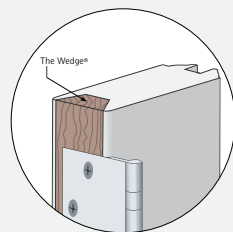

HARDWOOD WEDGE EDGE SYSTEM

TruStile MDF doors come standard with The Wedge,[®] our field-proven hardwood edge system. Designed to stand up to daily use, The Wedge provides superior rigidity, stability and screw-holding power.



Pair of TS6110 Doors in MDF with Roman Ogee (OG) sticking and Flat (C) panel

TruStile Reserve™ Wood Doors

Designed to the highest level of quality, TruStile Reserve Wood Doors are constructed using the latest technological advances combined with meticulous hand craftsmanship.



Exceptional color matching

Extremely stable engineered panel

Exceptional depth and dimension

Cope and stick joinery

LSL stiles and rails

THE ULTIMATE IN WOOD DOORS

- The TruStile Reserve series incorporates only the finest materials and construction methods.
- Engineered panel made with a composite core for strength and stability while maintaining the look of a solid wood panel construction.
- Precision-cut cope and stick joinery for a meticulous, uncompromising look.
- The strength and durability of LSL is employed for the ultimate in stiffness to resist bowing, twisting or warping.

EXCEPTIONAL HAND-MATCHED VENEERS

TruStile created a proprietary color matching and grading system to ensure only the best veneers and lumber are used to handcraft your door. Based on the AWI AA Premium Grade standard, but taken a step further, TruStile Reserve Doors are unmatched in beauty.



TS3000 in Mahogany with Espresso finish, Linea (LN) applied moulding and Flat (C) panel

TruStile Wood Doors

Made in the authentic stile and rail manner, TruStile Wood Doors use a premium mix of materials that exceed industry standards for a truly natural look.

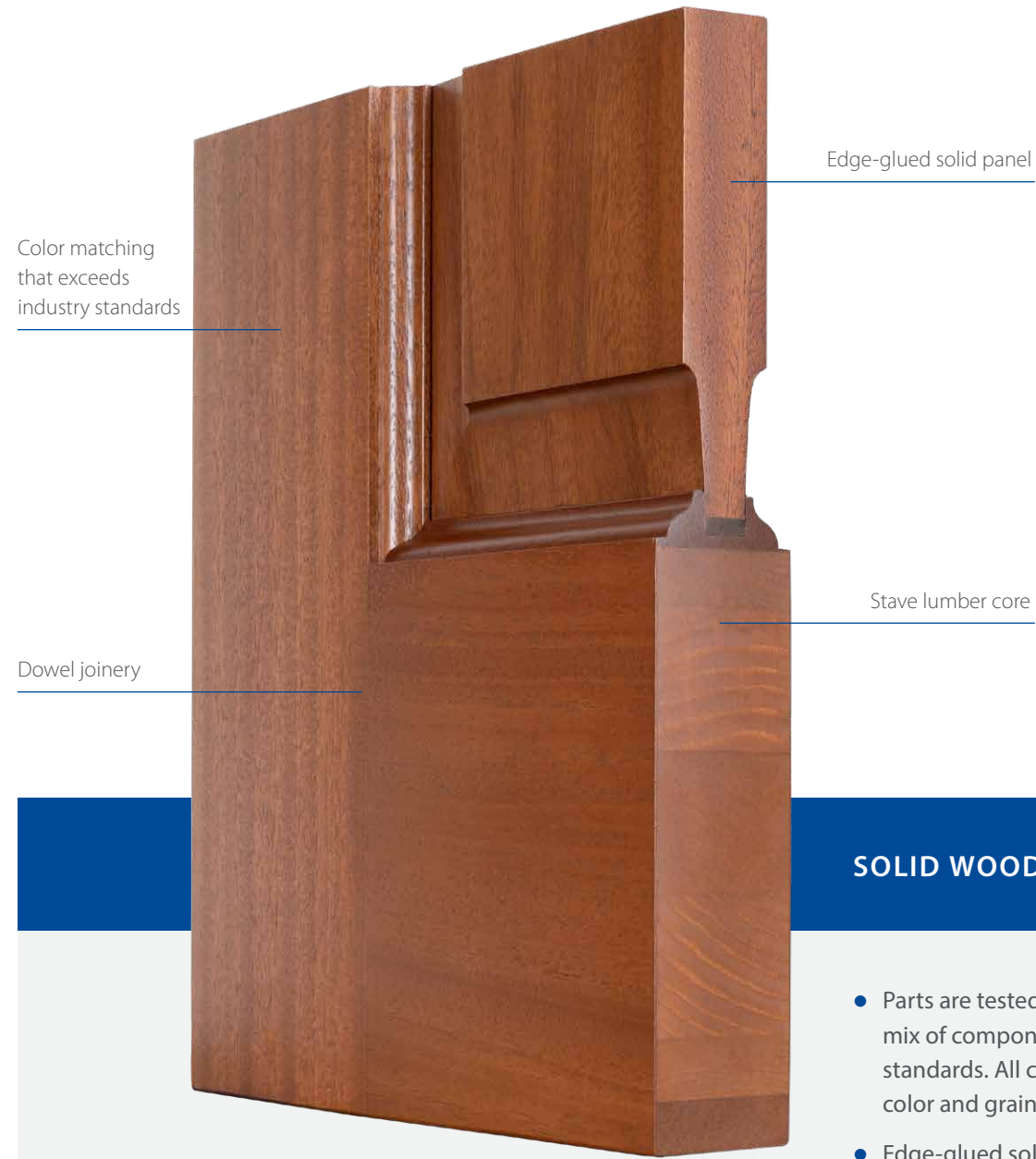

Color matching that exceeds industry standards

Edge-glued solid panel

Stave lumber core

Dowel joinery

SOLID WOOD QUALITY & DETAIL

- Parts are tested and sorted into a premium mix of components that exceed industry standards. All components are blended for color and grain pattern matching.
- Edge-glued solid wood panels for a premium look and feel.
- Traditional dowel construction enhances strength and durability.
- An engineered stave lumber core is cut to size with alternating grain patterns, which balances the core and reduces wood's natural tendency to move.

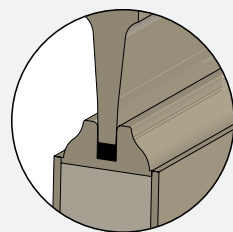

FLOATING PANEL SYSTEM

TruStile doors are engineered with a unique floating panel system that utilizes flexible cushions to allow expansion and contraction while securing the panel to prevent shifting, settling and rattling.



TS3010 in Cherry with Roman Ogee (OG) sticking and Raised (A) panel

Wood Species

TruStile offers the broadest selection of wood species on the market. Choose from our standard selections below, or custom order virtually any species. All of our standard wood species are available FSC® certified which ensures responsible forestry.

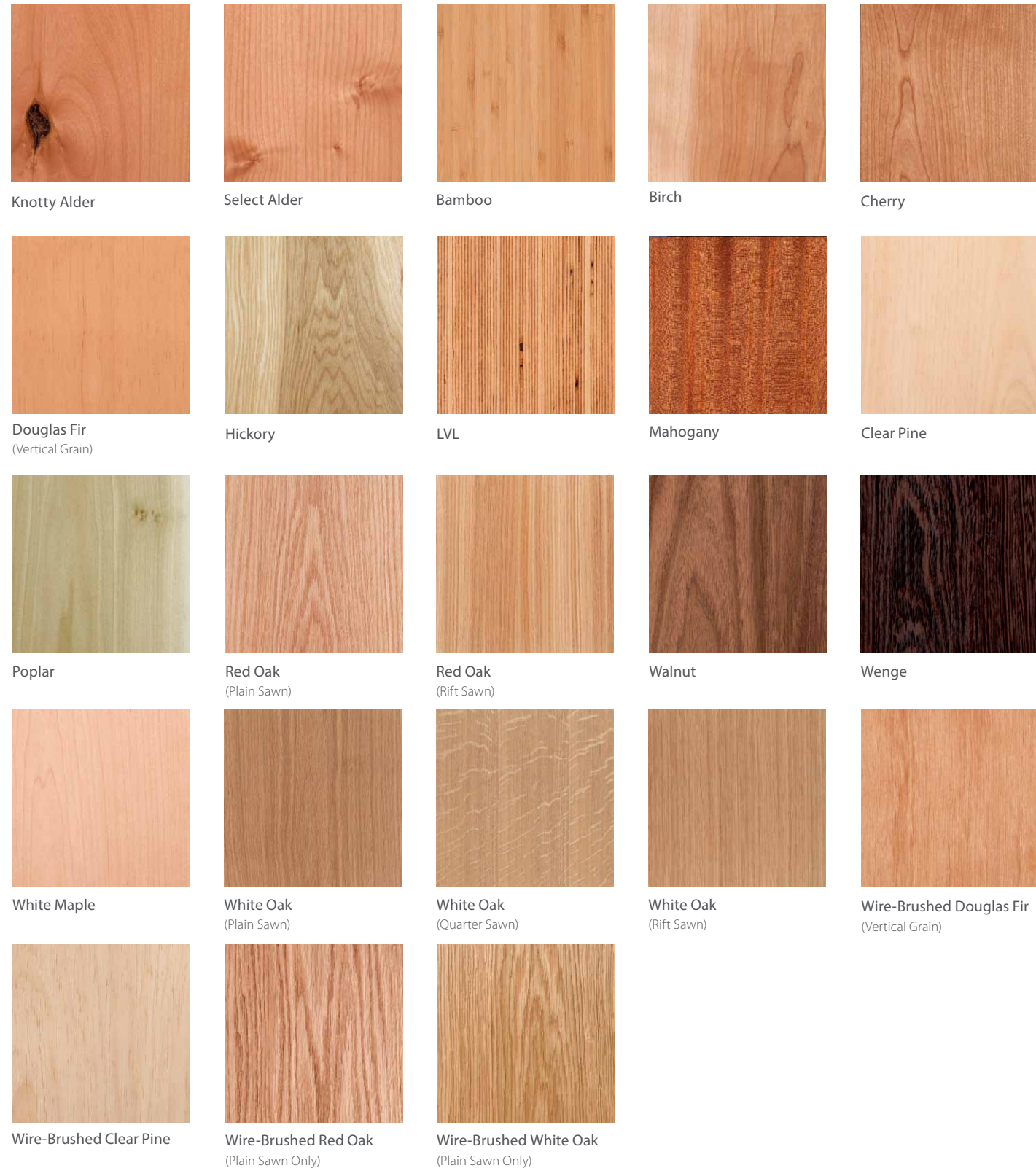

VG1000 in Select Alder with Cinnamon stain and Rustic Antiquing package.

Factory Pre-Finishing

TruStile offers a premium finishing capability that accentuates the natural beauty of our doors. Our exclusive process combines hand-wiped stains with a catalytic conversion varnish that results in an exceptionally beautiful finish luster.



Factory Pre-Hanging

Like our doors, TruStile's pre-hung units are built using premium construction techniques. Available as either pre-hung units or knock-down jambs, TruStile can supply any width and any species for any size door.

Available Hinge Finishes



Edelman® Leather

Substitute any panel with the finest Edelman leather. Select either a laminated or upholstered appearance for your leather panels.

In addition to our 12 standard color ways, visit www.edelmanleather.com for hundreds of additional leather choices.



Croc Black

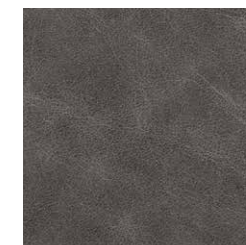

Dashing Old Sterling

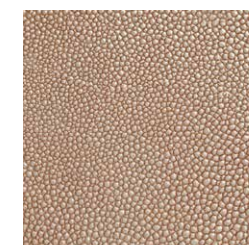

Shagreen Café Latte



Shagreen Caviar



Shagreen Couscous

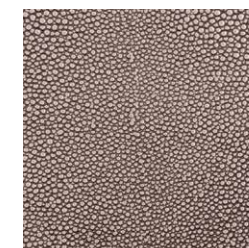

Shagreen Grey Oyster



Sulky Grey Mare



Oak



Pampas

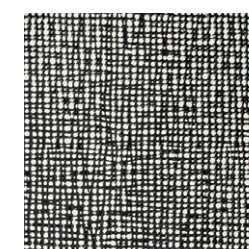

Wagon Lit Milk & Cookies

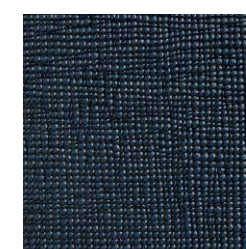

Wagon Lit Newest Navy

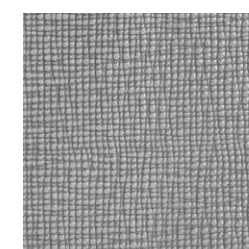

Wagon Lit Sonic

TM6100 barn doors in White Oak with Shagreen Grey Oyster leather and One Step (OS) sticking.

Chemetal® Inserts

High-quality wood and imaginative finishes combine for an entirely new perspective on what a modern interior can be. Choose the insert that inspires you.

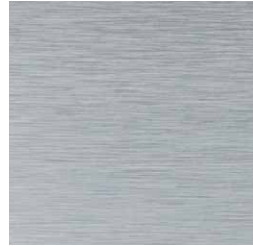

Brushed Aluminum



Brushed Brass



Brushed Bronze



Patina Aurora



Patina Canterbury



Patina Monet

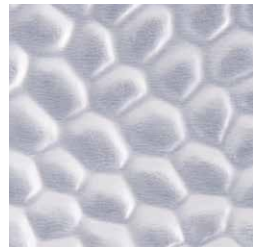

Hammered Argenta

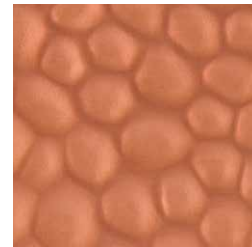

Hammered Cobblestone

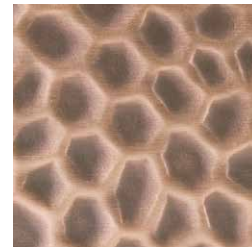

Hammered Reptilian



Serpentine



In addition to our standard finishes, visit www.chemetal.com for hundreds of additional choices.

TM3000 in MDF with One Step (OS) sticking and Patina Monet panels

Innovative Glass and Resin

Replace most any panel with the latest trends in architectural glass from Bendheim® or designer resin from 3Form®.



Clear



Bevel



Frosted



White Lami

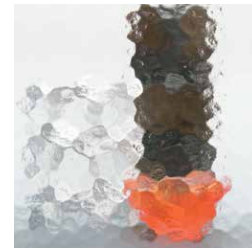

Arctic

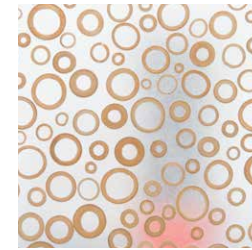

Bamboo Rings



Capiz



Brushed



Clear Leaf



Dash

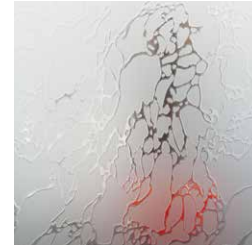

Delta Frost

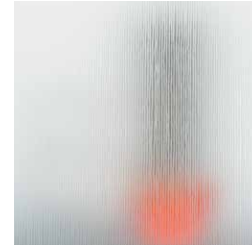

Flow

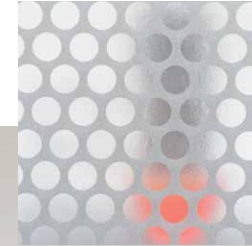

Cirque



Fossil



Glue Chip



Groove

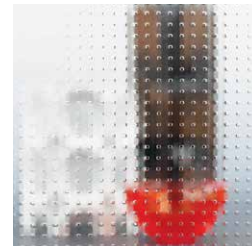

Master Carre



Obscure



Pinstripe



Ginkgo Thatch



Thatch

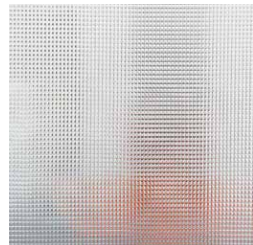

Quadra



Rain



Reeded



Satin Barcode



Seedy Wash

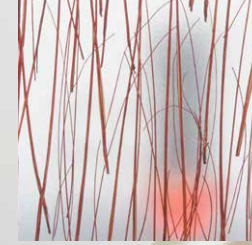

cappu



Shoji



Spun



Tuxedo



Wave



Whirl



Clear mirror



Bronze Fibers Mirror

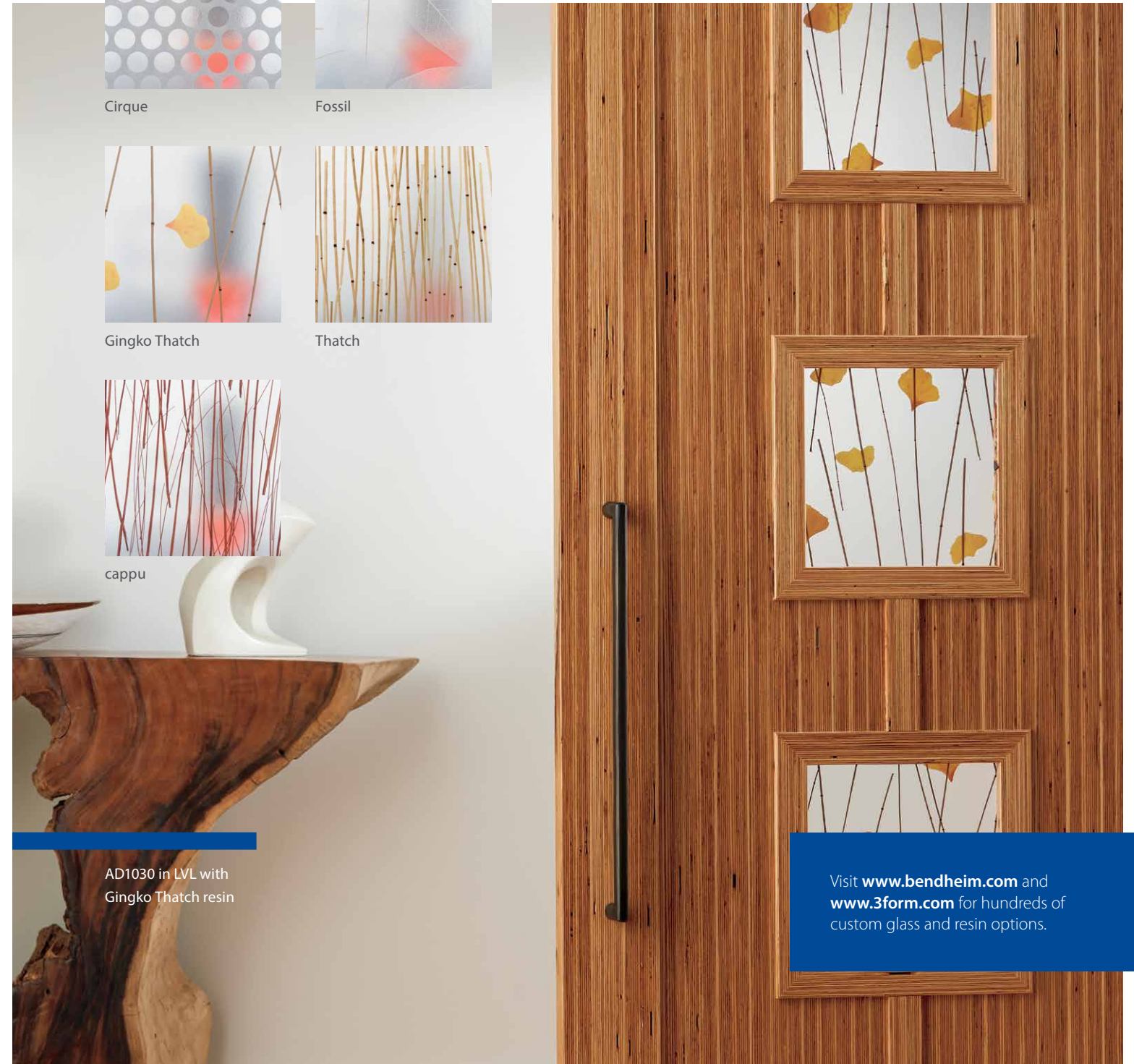

AD1030 in LVL with Ginkgo Thatch resin

Visit www.bendheim.com and www.3form.com for hundreds of custom glass and resin options.

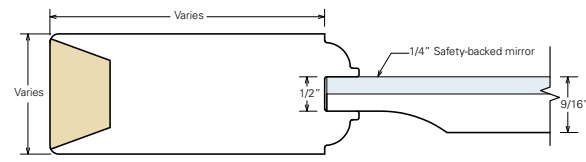

Sample cross section (one-sided mirror door)

Built-In Mirrors

TruStile mirror doors add a new dimension to any space. Our mirror doors are a perfect space-saving solution for bathrooms, closets, dressing rooms and other applications where a full-length mirror is required on one side.

Achieve total design form and function by substituting any solid panel for a mirror. Standard options include clear mirror and bronze fibers mirror.



Clear mirror



Bronze Fibers Mirror

Custom Etched Glass

Looking for something special for a pantry, wine cellar or office door? TruStile can custom etch any pattern, word or logo onto your glass doors.



Specify a full-length, built-in mirror on the back of any of our panel doors.

Backside of TM9000 in MDF features built in mirror. TM5000 with White Lami glass on left.

Design Options

TruStile's made-to-order flexibility makes it easy to customize the look of our 400+ standard doors with a collection of unique door options.

TS3160 common arch pair in MDF with Bolection (BM) moulding and Raised (A) panel



Arch-Top Doors
VG2020 AT in Douglas Fir



Radius-Top Doors
Custom radius-top door in MDF



Sliding Barn Doors
TM9320 in MDF with Brushed glass



Pocket Doors
FL1500 in Mahogany



Bi-Fold Doors
TS3160 in MDF



Bypass Doors
VG2020 in MDF



TS3040 Standard Pair



TS3040 Common Arch Pair

Common Arch Pairs

Rather than placing two matching doors side by side, common arch pairs carry details, such as curved panels and rails, across both doors. The end result? The doors actually look like they were made for the opening. Common arch pairs are also available with arch and radius tops.



Pivot Doors
TM9140 in LVL with custom metal



Clipped Corner Doors
Custom TS3010 in MDF



Dutch Doors
Custom TS2020 in Mahogany



Specialty Doors
Custom TS5060 in MDF

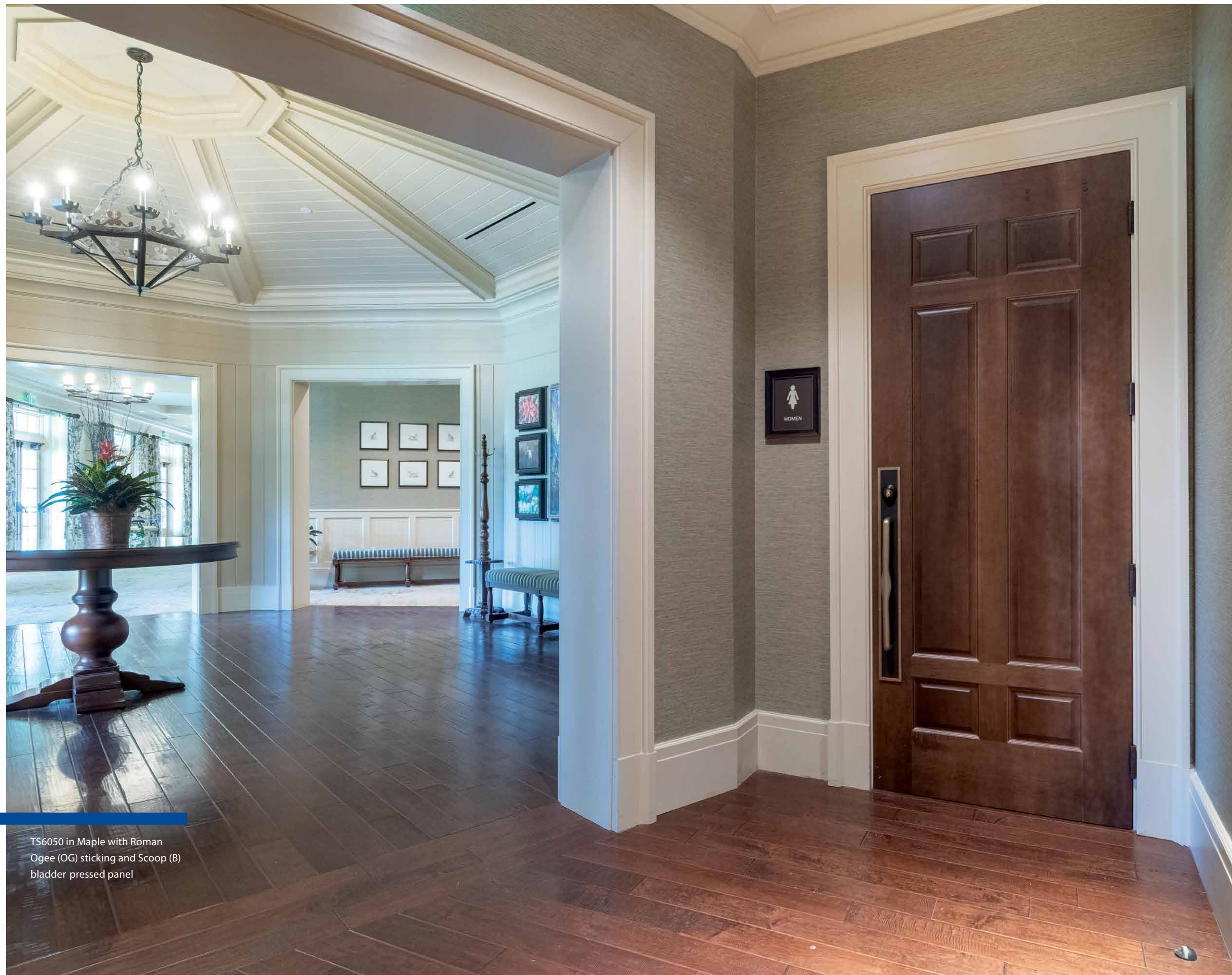

TS6050 in Maple with Roman
Ogee (OG) sticking and Scoop (B)
bladder pressed panel

Commercial Applications

From hospitality and high end multifamily projects to health care and educational institutions, TruStile provides the right finishing touches for distinctive projects across the United States.

TruStile doors can be built to meet any commercial specification including 20 through 90 minute fire ratings, ADA requirements and sound ratings.

Design Consistency Regardless of Function

Providing ultimate design flexibility, TruStile offers a spectrum of products for every project application. Whether passage, glass, fire or sound doors, TruStile allows you to maintain design consistency across all of your openings.



TS2020 in MDF with custom sticking

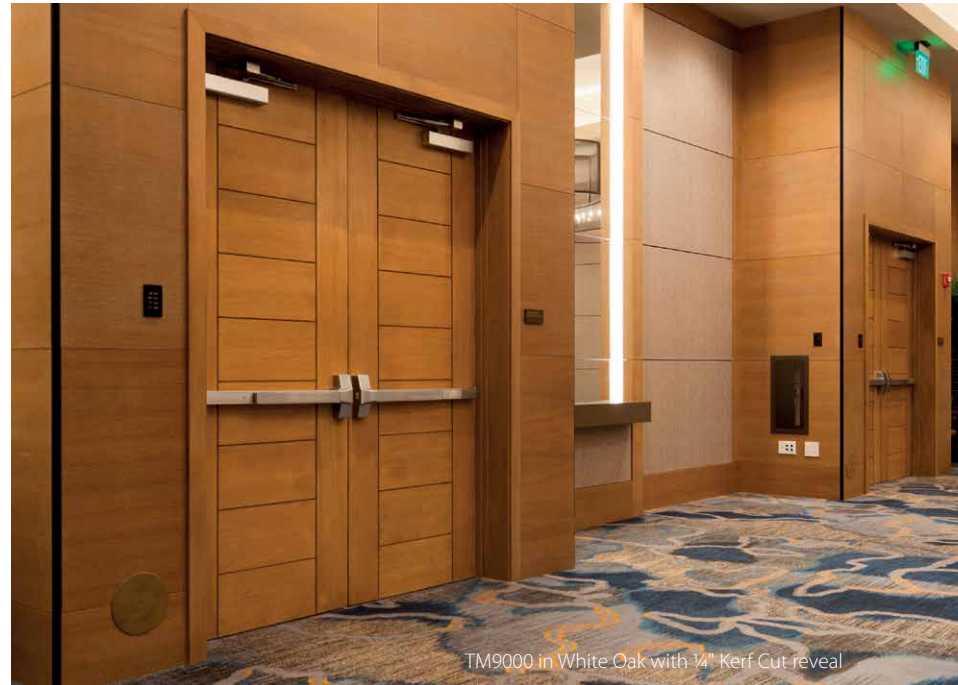

TM9000 in White Oak with 1/4" Kerf Cut-reveal

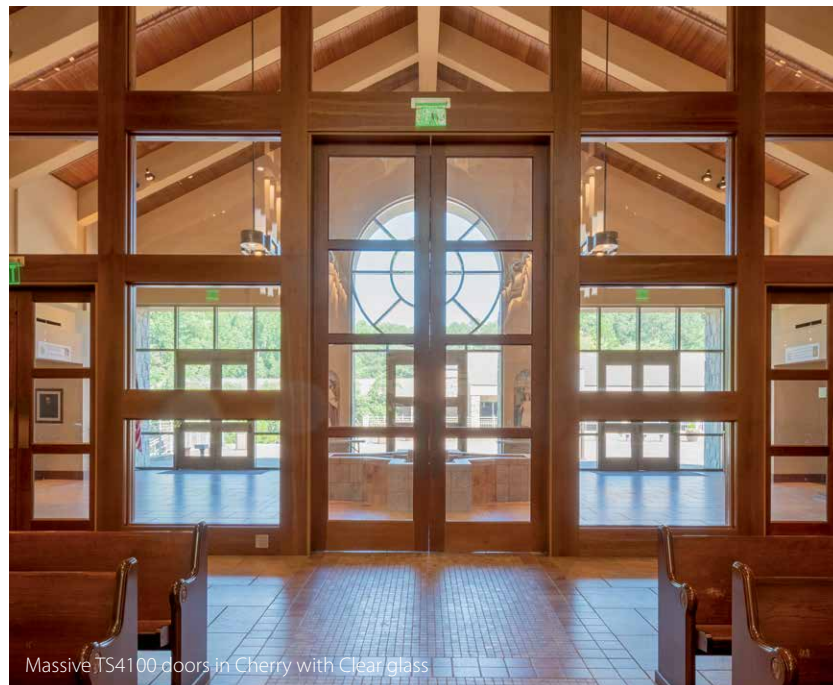

Massive TS4100 doors in Cherry with Clear glass



Historic match custom multi-panel doors in MDF with Bolection (BM) moulding and Senior Raised (E) panel.

Transform Openings & Elevate Your Project

TruStile designs premium doors for a wide array of market segments and distinctive properties across the United States.

Recent Projects

Hospitality

- Boutique Hotels & Spas
- Ace Hotel
- Albany Bahamas
- Algonquin Hotel
- The Jefferson Hotel
- Lake Yellowstone Hotel & Cabins
- Little Dix Bay
- Mills Park Hotel
- Mirbeau Inn & Spa
- Win-River Resort & Casino

Resorts & Destination Hotels

- Barnsley Resort – Adairsville, GA
- Fairmont Hotel – San Francisco
- Four Seasons – Boston
- JW Marriott – Washington DC
- Hilton – Nashville
- Hilton – Waikola
- Marriott – West Palm Beach
- Millennium – Scottsdale
- Omni Hotel – Amelia Island
- Renaissance – Aruba
- Renaissance – Austin
- Ritz Carlton – St Thomas
- Sheraton – Steamboat Springs
- Westin – Atlanta
- Westin – Hilton Head
- Wyndham – Puerto Rico

Healthcare

- Cohasset Senior Center
- Cosmetic Surgery Center of Maryland
- Brightmore of South Charlotte
- Friendship House at Royal Oaks
- Mount St Joseph
- OK Kids Korral
- Tockwotton on the Waterfront

Education

- Agnes Scott College
- Rebekah Scott Hall
- Auburn University
- Duncan Hall
- Butler University
- Delta Gamma
- Columbia University
- Teachers College
- Cristo Rey High School
- Dartmouth College
- Kappa Delta
- Middlesex School
- Notre Dame Community Housing
- Pepperdine Student Apartments
- Phillips Exeter Academy
- University of New Haven Dormitory
- Vassar College

Office/Retail

- Athleta/Gap/Banana Republic
- Bass Pro Shops
- Beverly Bank
- Chicago Motor Club
- First Southern Bank
- Goldring Office Building
- Grubbs Infiniti Dealer
- Waters Professional Building
- White House Black Market

Entertainment

- Canoe Brooke Country Club
- Charles River Country Club
- Cuban Museum
- Eugene O'Neill Theater Center
- Gaithersburg Art Barn
- The Hermitage Club
- Kansas State Casino
- Noah's of Katy at Mason Creek
- Universal Studios/Harry Potter
- Woodforest Golf Club

Multi-Family

- 333 North Michigan Avenue
- 530 Park Condo
- 1301 North Astor Street
- Phillip Maher Building
- Adam Gordon's 560 West Chelsea
- The Aurora Apartments
- The Austonian
- Coronado Bay Club
- Huys – 404 Park Avenue South
- Hotel Sorella Residences
- Loews North Park Drive
- Mansions at Aqualina
- Old Mill Toronto
- Printhouse Lofts, Brooklyn
- Rittenhouse Plaza
- The Shire
- Two Twenty Four Mulberry Street
- Uptown Condos

Government/Public

- Chester County Courthouse
- Denver Union Station
- Dumbarton Oaks
- Fort Poke Office Building
- Santa Cruz Women's Shelter
- Sumter County Courthouse
- Presidio Officer's Club

Religious

- Benedictine Sisters Retreat Center
- Good Shepard Catholic Church
- Mission Del Ray
- Parkside Church
- St. George Christian Church
- St. John Neumann

Design that Complements the Planet

Our modern, domestic plants use lean manufacturing practices to make extremely efficient use of our raw materials. This minimizes waste and environmental impact.



69% Recycled MDF Doors for Painted Applications

TruStile MDF doors are not only the highest quality paintable doors on the market, they are also the responsible environmental choice. We recycle MDF waste, donating it to agricultural partners who use it to create energy, reducing both landfill waste by 65% and waste pick ups, putting fewer trucks on the road. The green benefits of our MDF doors include:

- Certified by SCS Global Services to be constructed of 69% recycled content.
- Eligible for up to three LEED® credits
- Manufactured with low-emitting adhesives and coated with low-emitting primer.
- Standard MDF is low emitting, meeting CARB (California Air Resources Board) requirements.
- A no-added formaldehyde MDF option is also available.

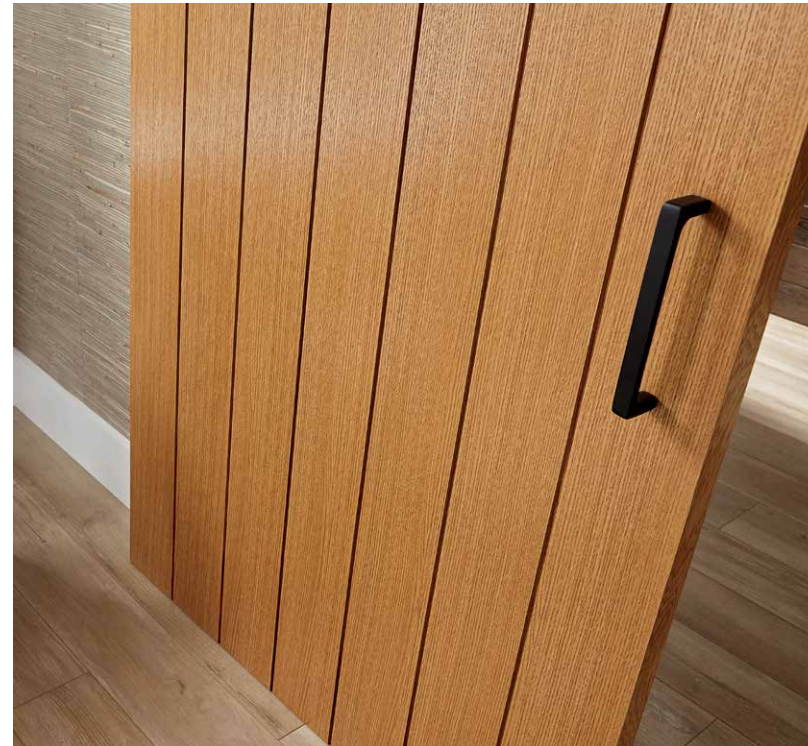

FSC® Certified Wood Doors for Stained Applications

Most TruStile wood doors are available with FSC certification. FSC certification ensures that products come from responsibly managed forests that provide environmental, social and economic benefits. The green benefits of our FSC certified wood doors include:

- Third-party certification that all door materials originate from responsible sources.
- 100% of door value contributes towards the LEED credit for Certified Wood Products.
- Manufactured with low-emitting adhesives.
- Green-certified doors contain the same high-quality construction and materials as our standard product.



Use TruStile on Your Next LEED® Certified Project

The LEED® (Leadership in Energy and Environmental Design) Green Building Rating System is a national standard developed and published by the U.S. Green Building Council (USGBC). Its purpose is to promote sustainable building that is environmentally responsible, profitable and healthy. TruStile doors also qualify for other green building rating systems. Contact us for details.

TruStile Doors help achieve LEED credits in the following categories for new commercial construction and major renovation projects¹:

LEED credit	LEED criteria	Detailed requirement	TruStile MDF	TruStile Wood
Materials & Resources				
4.1 (1 point)	Recycled content: 10% (post-consumer + ½ pre-consumer)	Use materials with recycled content such that the sum of post-consumer recycled content plus ½ of the pre-consumer content constitutes at least 10%, based on cost, of the total value of the materials in the project.	Qualify – SCS certified to contain minimum 69% recycled content	Not eligible
4.2 (1 point)	Recycled content: 20% (post-consumer + ½ pre-consumer)	Use materials with recycled content such that the sum of post-consumer recycled content plus ½ of the pre-consumer content constitutes at least 20%, based on cost, of the total value of the materials in the project.	Qualify – SCS certified to contain minimum 69% recycled content	Not eligible
7 (1 point)	Certified wood	Use a minimum of 50%, based on cost of wood-based materials and products that are certified in accordance with the Forest Stewardship Council's (FSC) principles and criteria for wood building components.	Not eligible	Qualify – specify FSC Certified Wood Door 100% of door value counts toward credit
Indoor Environmental Quality				
4.4 (1 point)	Low-emitting materials: Composite wood and agrifiber products	Composite wood and agrifiber products used on the interior of the building must contain no added urea-formaldehyde resins.	Qualify – specify ULEF or NAF MDF	Qualify – specify ULEF or NAF MDF panel core

TruStile Doors help achieve LEED credits in the following categories for residential home construction projects²:

LEED credit	LEED criteria	Detailed requirement	TruStile MDF	TruStile Wood
Materials & Resources				
2.2 (0.5 points for doors)	Environmentally preferable products	Use building component materials that are environmentally preferable in that they either contain minimum of 50% post industrial recycled content, are FSC certified or reclaimed.	Qualify – SCS certified to contain minimum 69% recycled content	Qualify – specify FSC Certified Wood Door 100% of door value counts toward credit

¹ LEED for New Construction & Major Renovations, Version 3 (April 2009).

² LEED for Homes Rating System, Version 2008 (January 2008).

Our Fire Doors are as Stylish as They are Safe

Designed to match non-rated doors, all TruStile fire doors feature full panel relief and are carefully engineered to complement our non-rated doors.



20-minute fire-rated TS3070 in MDF

Matched Dimensions

Stile and rail dimensions can be matched between standard and fire rated doors.

60 MINUTE FIRE DOOR NON RATED DOOR

Profiles on fire-rated doors have true depth and definition, not plant on mouldings.



Non-rated TS3070 in MDF

Certified Fire Door Ratings

Throw away the preconception that you have limited design options for fire-rated openings. With most of our standard panel doors available in up to 90-minute ratings, you never have to sacrifice style when selecting 20- through 90-minute fire doors.

	20-minute MDF	20-minute Wood	45- and 60-minute MDF/Wood	90-minute MDF/Wood
Category	Category A Category B Neutral Pressure	Category A Category B Neutral Pressure	Category A Category B	Category A Category B
Thickness	1¾" minimum	1¾" minimum	1¾" minimum	1¾" minimum
Maximum width single	4'0"	4'0"	3'6"	3'6"
Maximum width pair	8'0"	8'0"	7'0"	7'0"
Maximum height	8'0"	8'0"	8'0"	8'0"
Fire Glass max. area	3,145 sq. inches	3,145 sq. inches	1,248 sq. inches – 45 minutes 1,216 sq. inches – 60 minutes	1,216 sq. inches
Standards	ASTM E-152, NFPA 80, NFPA 252, UL10B, UL10C			

¹ Some door styles and panel profiles are not available in all fire ratings. Verify availability with TruStile.

² Some ratings require metal vision kits.

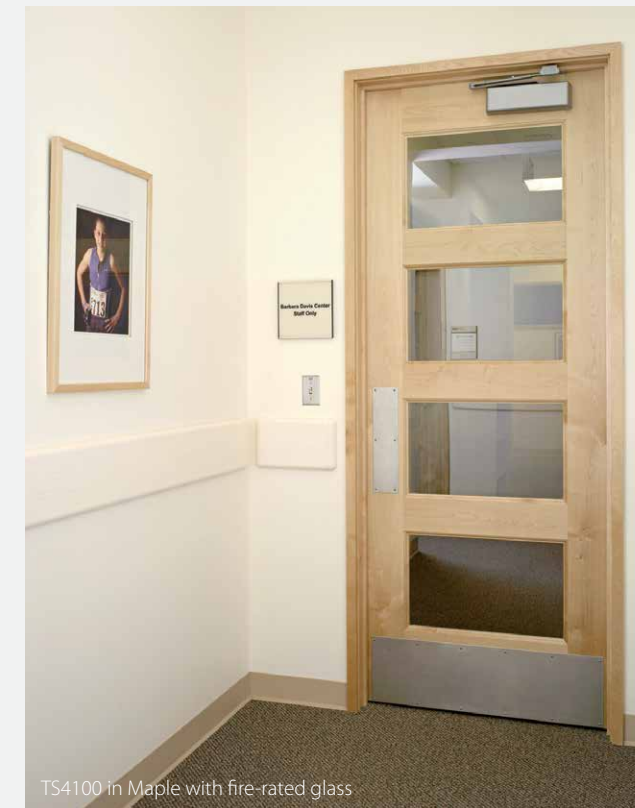

TS4100 in Maple with fire-rated glass

Fire-Rated Glass Doors Also Available

Glass doors are the perfect solution for spaces where a fire door is required by code, but the look of a glass door is preferred. Select from over 120 fire rated glass doors with any of our standard sticking profiles.

Refer to the fire rated symbol  in the Door Collections section to see which glass door designs are available in 20 , 45 , 60- and 90 minute fire ratings.

Hose stream approved glass can also be specified.

Superior Sound Performance

Noise is an inescapable component of life in the modern home. Because of their weight, solid construction and high density, TruStile doors are the ideal solution to sound proofing a home.

Keep Private Conversations Private

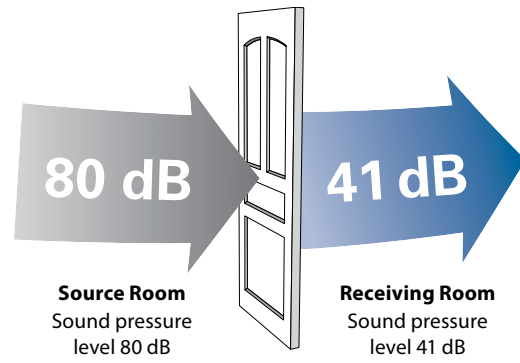

Home theater featuring TS3070 in Mahogany with custom porthole window

Sound Transmission Class (STC) Ratings

TruStile has tested its sound doors in operable openings with Zero International sound gasketing packages.

STC Rating	Door Material	Door Styles	Door Thickness	Primary Seal	Secondary Seal	Threshold Saddle	Sweep
Zero International hardware used							
39	MDF & Wood	45- & 60-Minute Fire Door	2-1/4"	#475	#119	#564	#367
38	MDF	90-Minute Fire Door	1-3/4"	#188FS	#118B	Flat Surface	#369
34	MDF	TS5XXX through TS9XXX	1-3/4"	#475	#119	#564	#367
33	MDF	TS1XXX through TS4XXX	1-3/4"	#475	#119	#564	#367
32	MDF	TS5XXX through TS9XXX	1-3/4"	#475	None	#564	None
32	Wood	TS1XXX through TS4XXX	1-3/4"	#475	#119	#564	#367
30	MDF	TS1XXX through TS4XXX	1-3/4"	#475	None	#564	None
30	Wood	TS5XXX through TS9XXX	1-3/4"	#475	#119	#564	#367
30	Wood	TS1XXX through TS4XXX	1-3/4"	#475	None	#564	None

Sound Transmission Class (STC) Examples

TruStile Advantage	STC	Performance	Description
	50 – 60	Excellent	Loud sounds heard faintly or not at all
	40 – 50	Very Good	Loud speech heard faintly
TruStile Door with Recommended Gasketing	35 – 40	Good	Loud speech heard but hardly intelligible
	30 – 35	Fair	Loud speech understood fairly well
	25 – 30	Poor	Normal speech understood easily and distinctly
Typical Hollow-Core Door	20 – 25	Very Poor	Low speech audible

Sound ratings are classified by an STC (sound transmission class) number that rates a material's ability to resist airborne sound. A higher STC rating blocks more noise from transmitting through a partition like a door. Standard TruStile MDF doors achieve up to a 34 STC rating, some 10- to 15-points better than typical hollow-core doors that achieve a "very poor" rating. For openings requiring even better sound performance, TruStile can provide 60-minute wood and MDF fire doors that achieve up to a 39 STC rating.

NEW

Entry Systems

TruStile Entry Doors has extended the design leadership we pioneered with interior doors to the front entry of the home. We are pleased to bring you more choices, a higher quality product, and a more inspired, easier journey to selecting the ideal entry for your home. Now you can make a statement throughout your whole home.



For more information about TruStile's new entry systems, visit www.trustile.com or request a copy of our *Exceptional Entrance*, entry door catalog.



TruStile entry systems are solely available for residential applications.



Pair of FL110 doors in MDF with Roman Ogee (OG) sticking, Raised (A) panel and Clear glass

The Extensive TruStile Door Collection

Find the ideal design that enhances your home's architectural style and completes its distinctive look.

TS Series Door Collection

Our TruStile (TS) Door Collection features over 100 architecturally-correct panel door styles from one- to nine-panel configurations. Each door is built with genuine stile and rail construction and is never routed or stamped. As a result, our panel - doors have crisp, clean lines and unmatched detail.

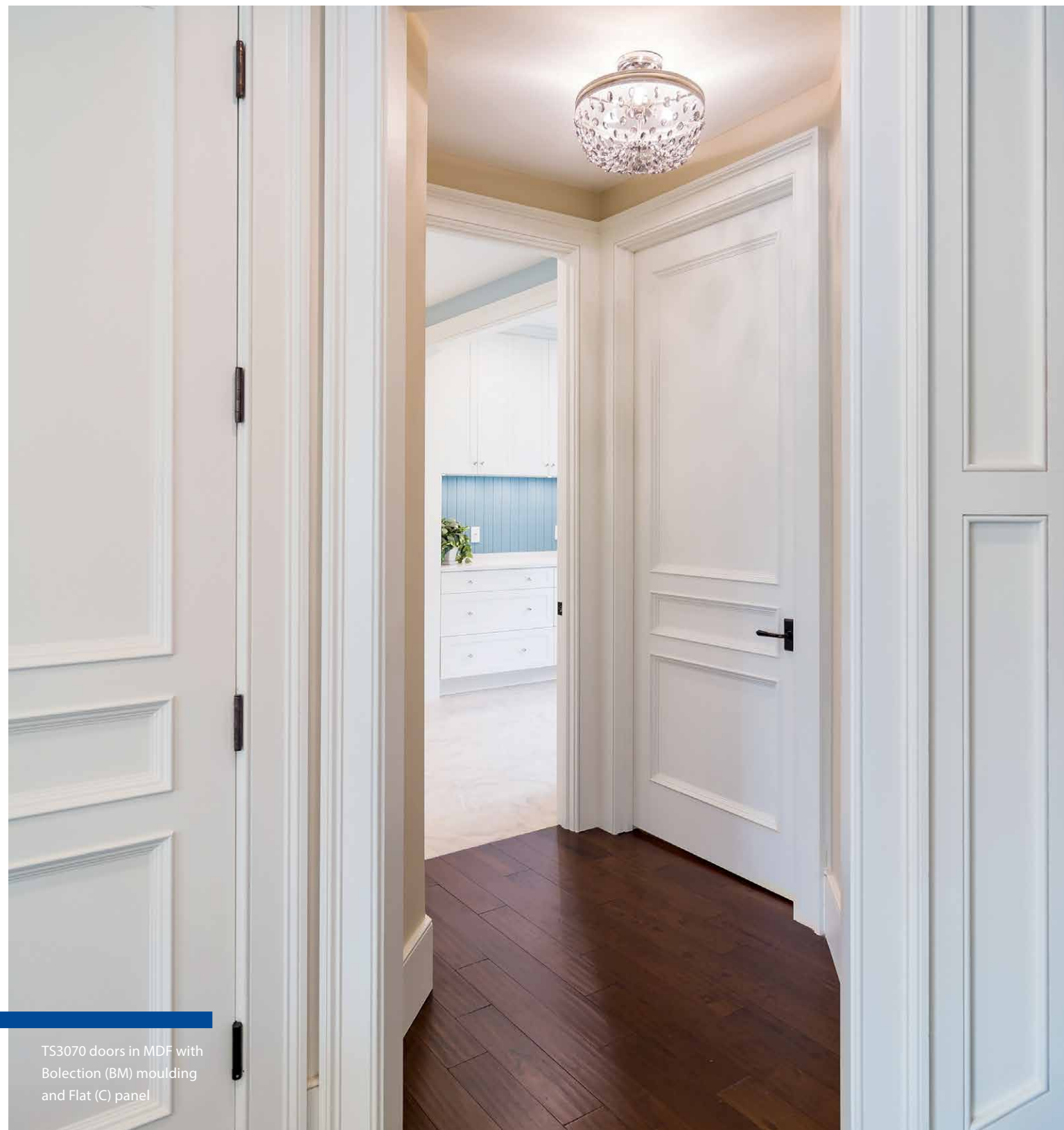

TS3070 doors in MDF with Bolection (BM) moulding and Flat (C) panel

TS1000	TS1010	TS1030	TS1050	TS2000	TS2010	TS2020	TS2030	TS2040	TS2050	TS2060
TS2070	TS2080	TS2090	TS2130	TS2160	TS2170	TS2180	TS2190	TS2200	TS2210	TS2220
TS2230	TS2240	TS2250	TS2260	TS3000	TS3010	TS3020	TS3030	TS3040	TS3050	TS3060
TS3070	TS3080	TS3090	TS3100	TS3110	TS3120	TS3130	TS3140	TS3150	TS3160	TS3170

- Available TruStile
- Product Options
- Available as a fire-rated door*
- Arch-top option available
- Radius-top option available
- Common arch pair option available
- Bi-fold closet option available
- Available in MDF only

*Contact TruStile to confirm exact fire ratings and available sizes

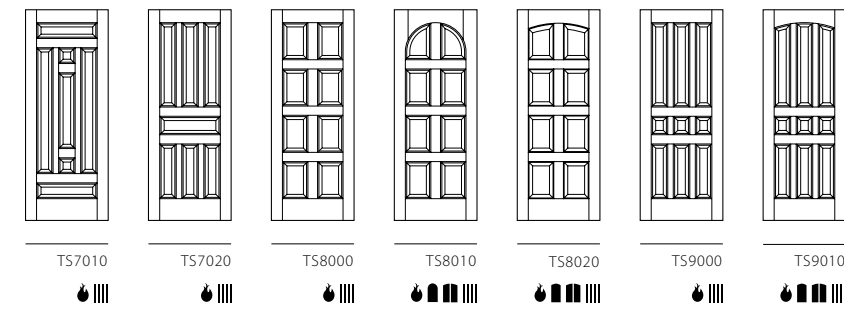
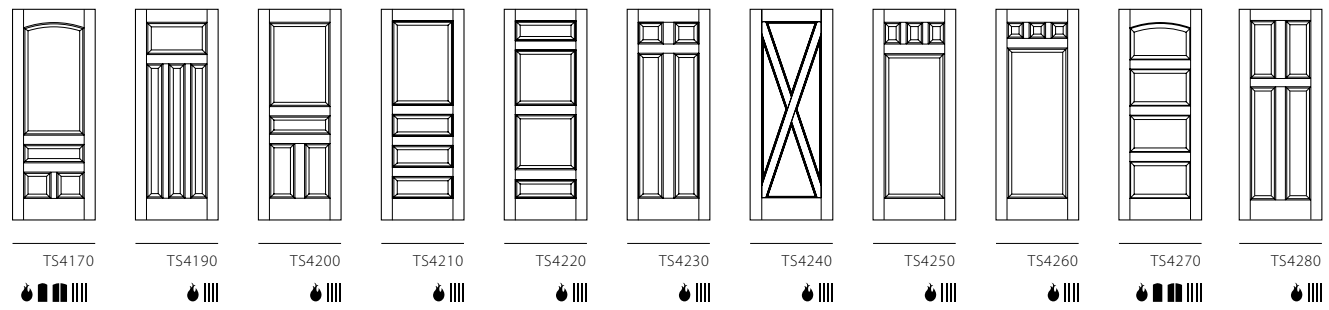
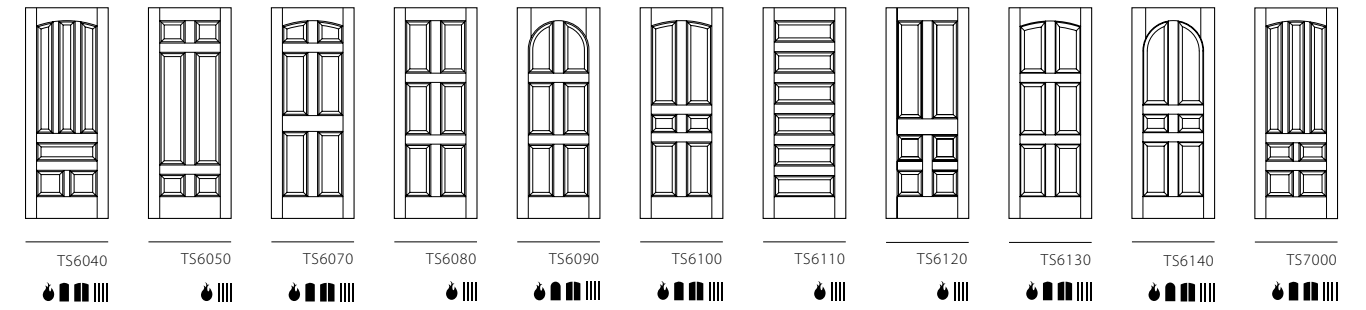
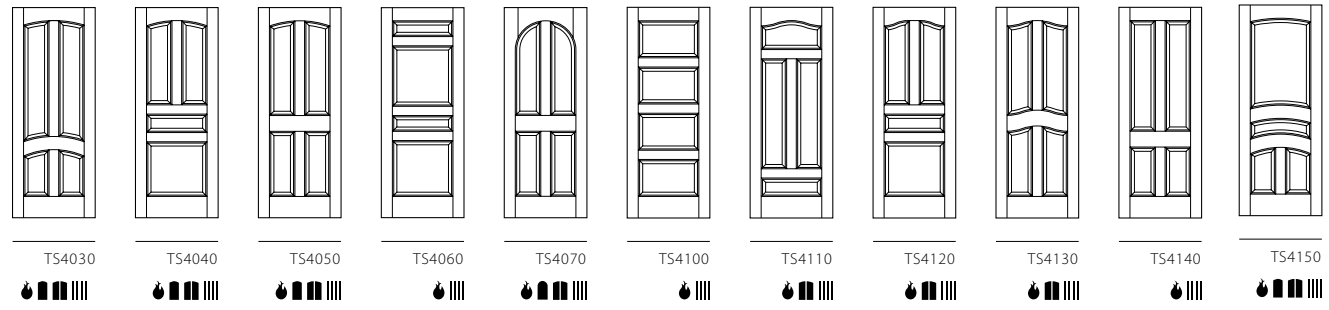
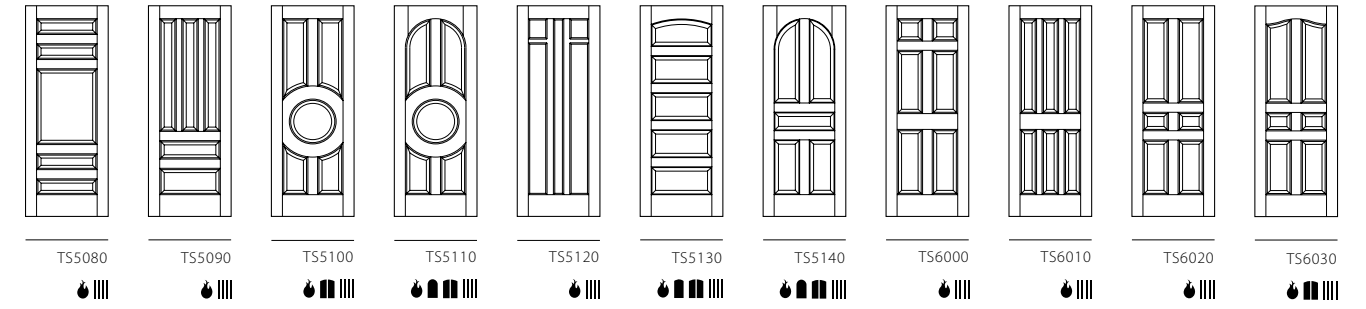
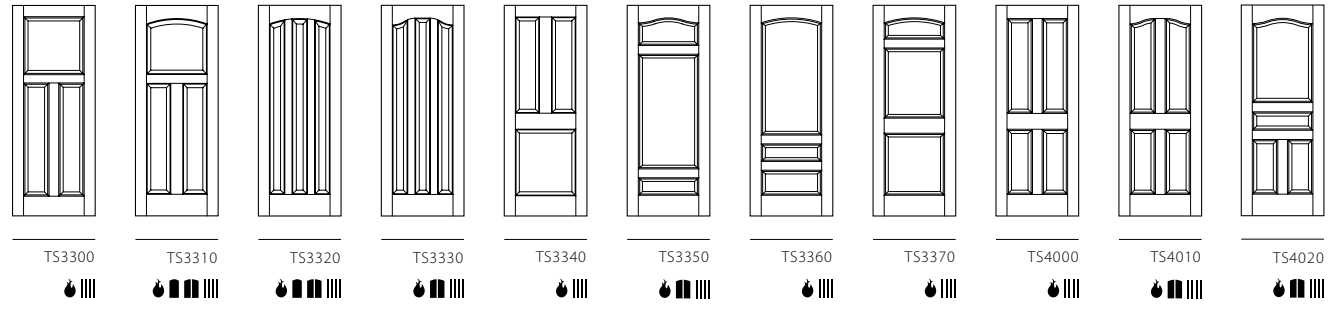
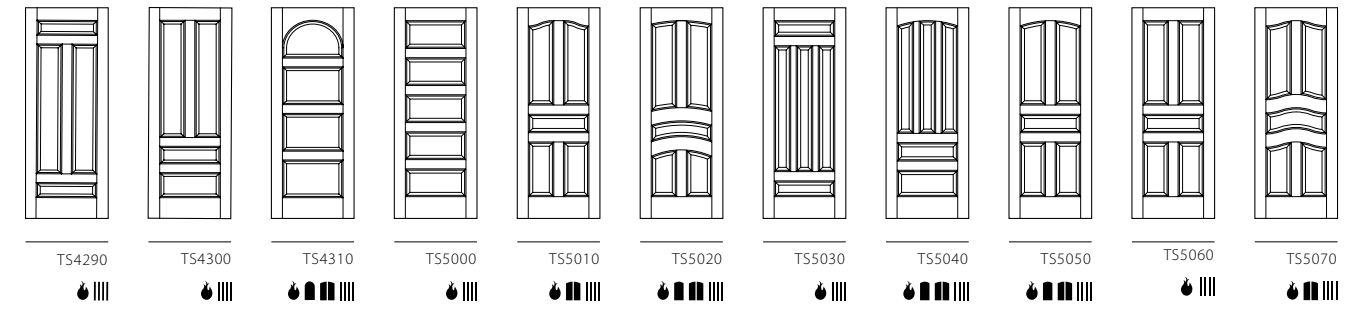
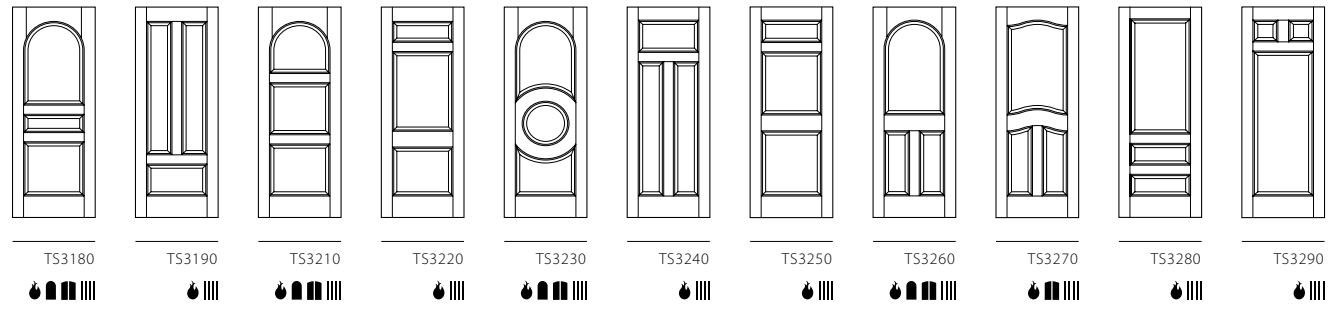

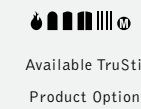
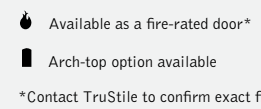
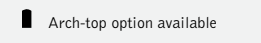
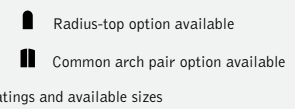
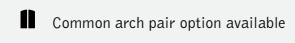
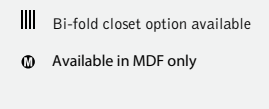
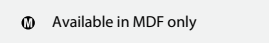
 Available TruStile Product Options
  Available as a fire-rated door*
  Arch-top option available
  Radius-top option available
  Common arch pair option available
  Bi-fold closet option available
  Available in MDF only

*Contact TruStile to confirm exact fire ratings and available sizes

Panel Door Profile Options

A door profile refers to the joint where the sticking and panel come together. You can achieve distinct looks by selecting different sticking and panel combinations. With so many combinations to choose from, we're confident you'll find the perfect profile for your project. If not, we can partner with you to create a custom profile.



Pair of TS1000 doors in MDF with Miracle (MR) applied moulding

Sticking and Moulding Options

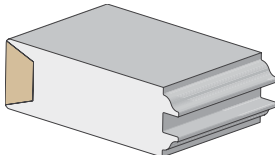
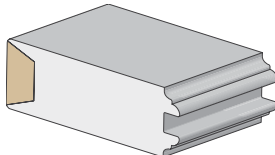
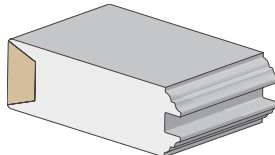
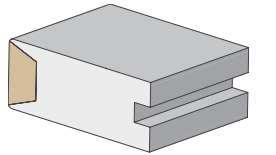
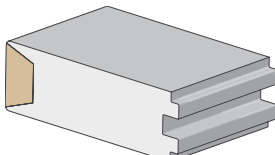
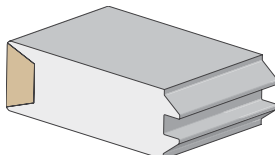
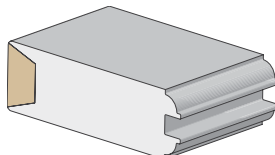
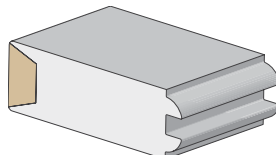
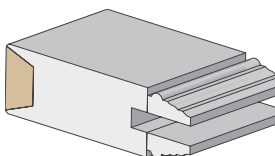
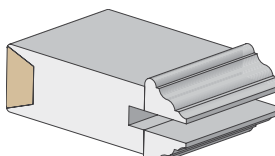
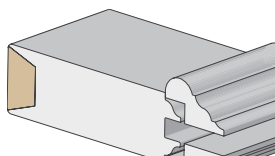
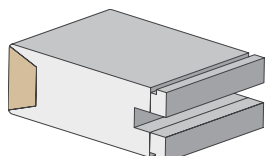
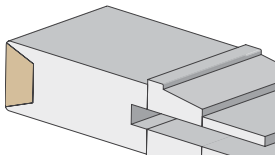
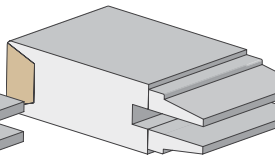
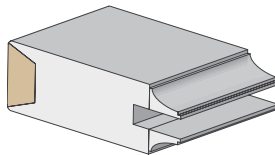
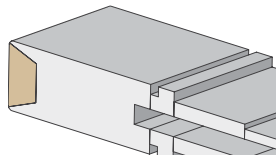
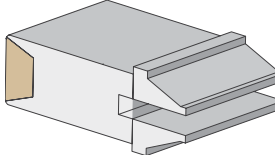
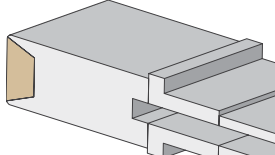
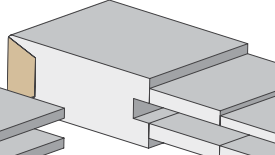
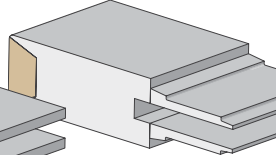
			
Roman Ogee (OG) Sticking	Cove & Bead (CB) Sticking	Traditional (TR) Sticking	Square Stick (SS) Sticking
			
One Step (OS) Sticking	Bevel (BV) Sticking	Quarter Bead (QB) Sticking	Quarter Round (QR) Sticking
			
Low Profile Bolection (LP) Moulding	Bolection (BM) Moulding	Big Bolection (BBM) Moulding	Quirk (QM) Moulding
			
Avant (AV) Applied Moulding	Avant Low Profile (AVLP) Applied Moulding	Cove (CV) Applied Moulding	Empire (EM) Applied Moulding
			
Evoke (EV) Applied Moulding	Linea (LN) Applied Moulding	Linea Low Profile (LNLP) Applied Moulding	Miracle (MR) Applied Moulding

Panel Options

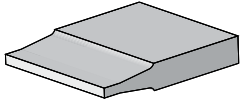
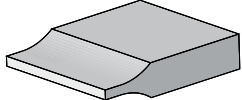
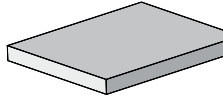
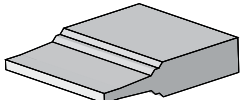
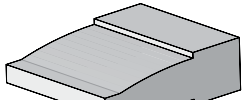
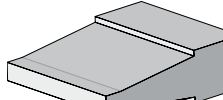
		
Raised (A) Panel	Scoop (B) Panel	Flat (C) Panel
		
Double Hip (D) Panel	Senior Raised (E) Panel	Senior Bevel (F) Panel

TM Series Door Collection

The Tru&Modern™ (TM) Door Collection consists of over 100 contemporary door styles. A modern take on classic stile and rail door construction. Clean, strong lines. Custom design options. Bold accents. This collection radically alters the concept of what a door can bring to today's modern and contemporary interiors.



TM13000 in MDF with 1/4" Kerf Cut reveal

TM Series Door Styles

Modern Adaptation Door Styles

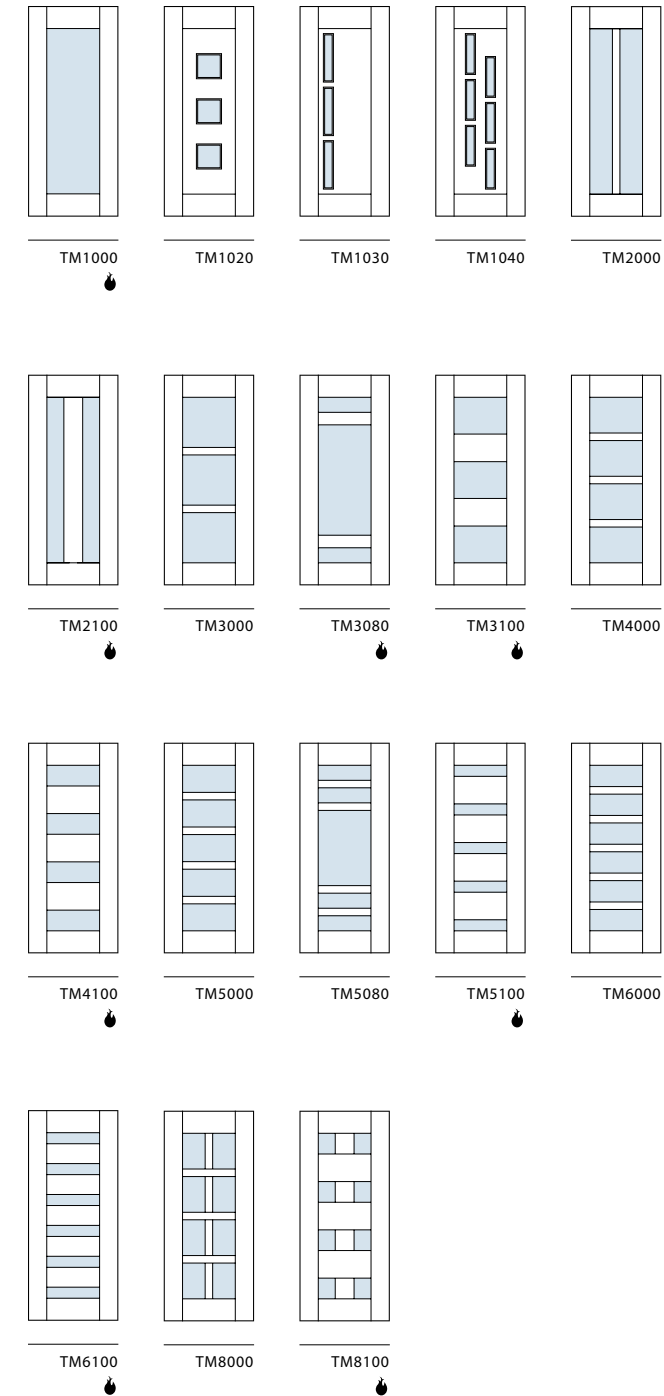

Profile Options

TM Series modern adaptation designs are available with two profile options to frame the desired insert:

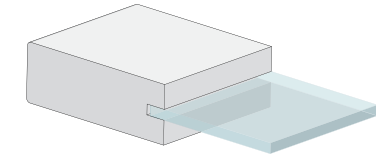

Square Stick (SS) Compression Fit

Compression fitting not available for leather inserts. Glass can not be replaced on compression fit doors.

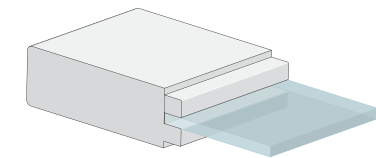

Square Stick (SS) Sash

Square Stick sash not available on MDF or wood used as a panel insert. Use One Step (OS) sticking to match Square Stick (SS) sash around wood inserts.

Note: Door styles are shown with the new modern wide stile. Shaded panels indicate an insert option: leather, metal, glass, resin or a flat mdf or wood panel.

Available TruStile Product Options

Available as a fire-rated door*

Arch-top option available

*Contact TruStile to confirm exact fire ratings and available sizes

Radius-top option available

Common arch pair option available

Bi-fold closet option available

Available in MDF only

TM Series Door Styles

9-Rail Stacked Rail Door Styles

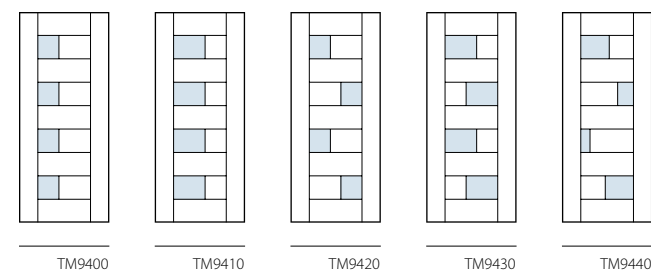
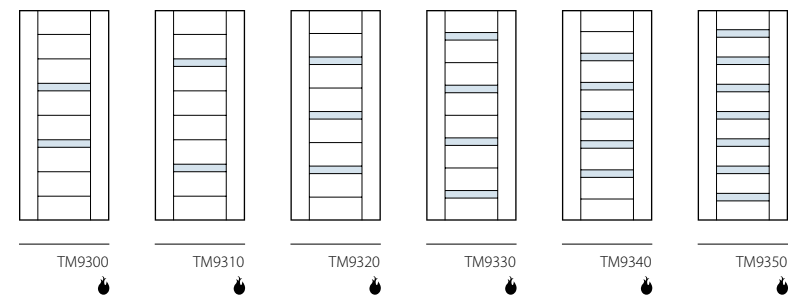
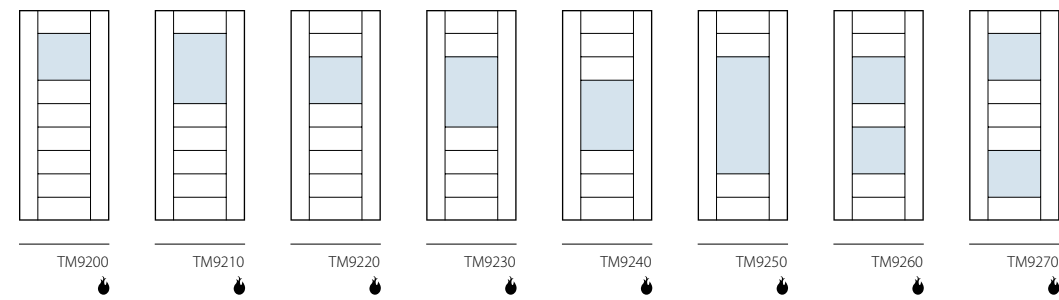
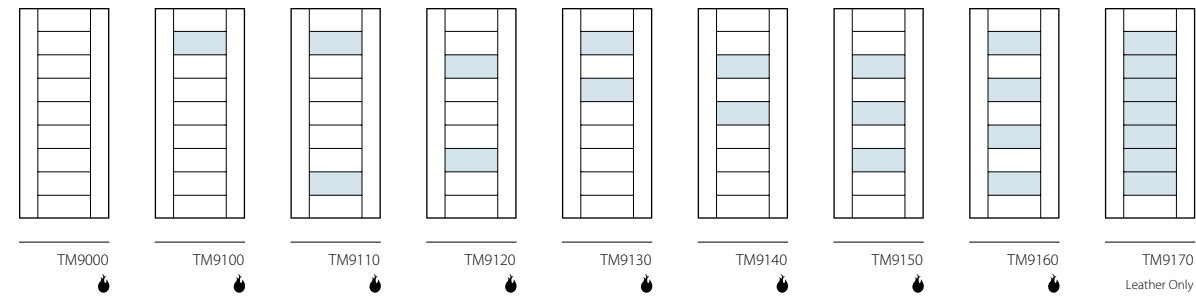

Reveal Options

TM series stacked rail door designs are available with two reveal options:

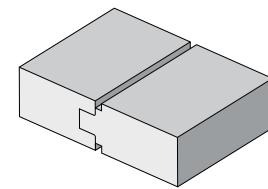

1/8" Radius Reveal
Subtle, dimensional look

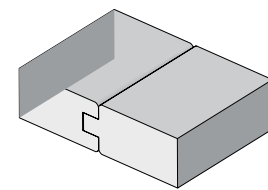

1/4" Kerf Cut Reveal
Bold, sharp lines

TM Series Door Styles

13-Rail Stacked Rail Door Styles

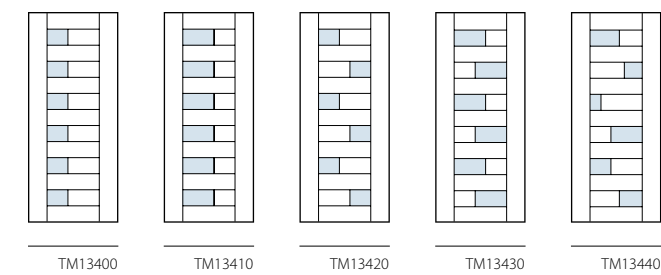
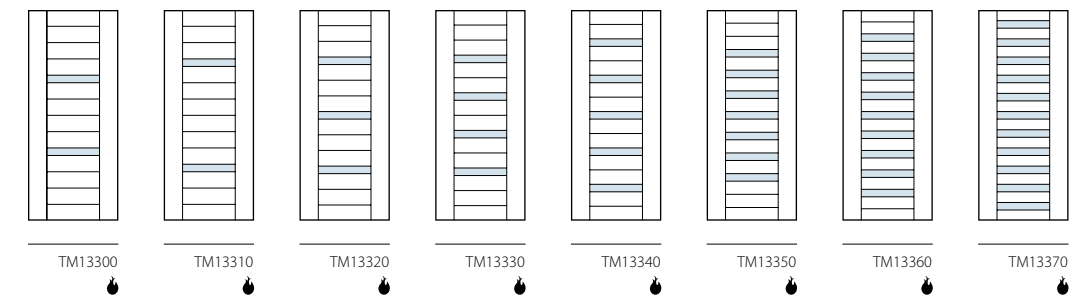
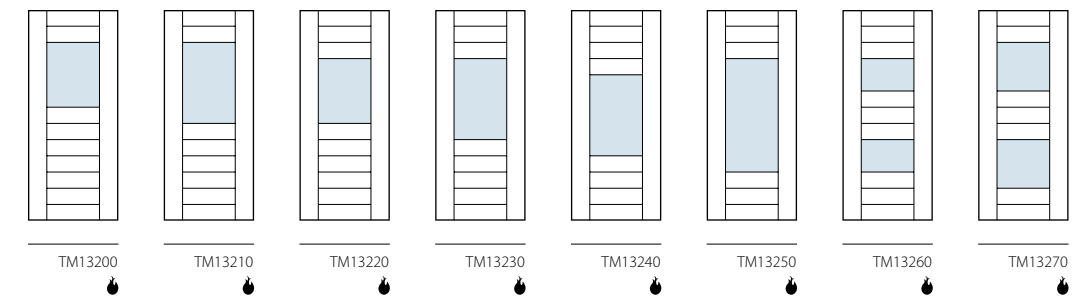
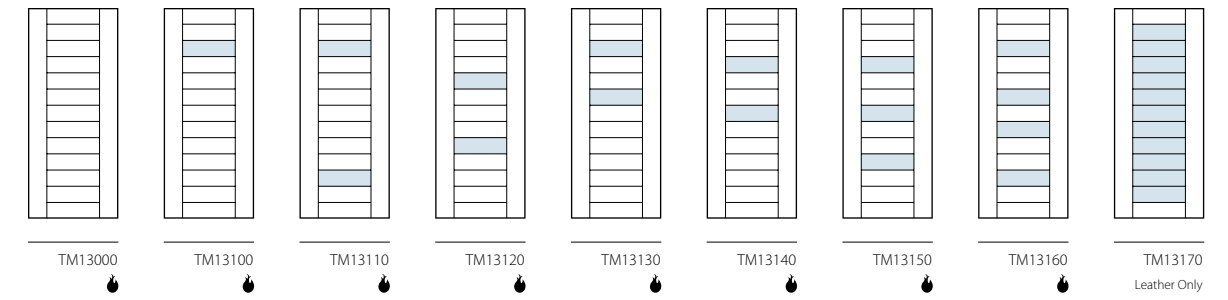

Note: Door styles are shown with the new modern wide stile. Shaded panels indicate an insert option: leather, metal, glass, resin or a flat mdf or wood panel.

Available TruStile Product Options

Available as a fire-rated door*

Arch-top option available

*Contact TruStile to confirm exact fire ratings and available sizes

Radius-top option available

Common arch pair option available

Bi-fold closet option available

Available in MDF only



TM4101 in MDF with 1/4" Kerf Cut reveal

TM Series Door Styles

Modern Kerf Door Styles

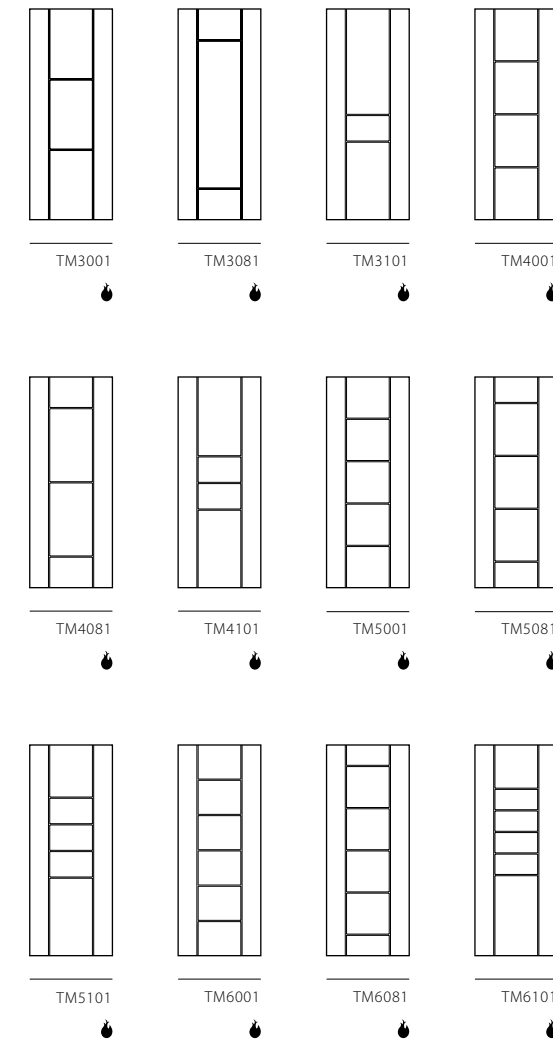

Reveal Options

TM series modern kerf door designs are available with the follow kerf reveals.

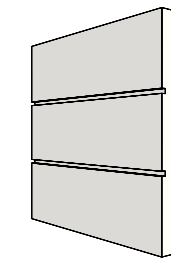

1/4" Kerf Cut Reveal

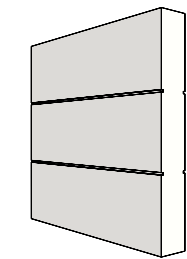

1/8" Kerf Cut Reveal
MDF Only

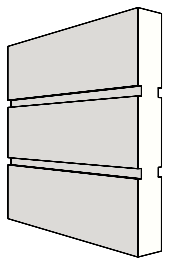

1/2" Kerf Cut Reveal
MDF Only

Note: Door styles are shown with a wide kerf configuration (which mimics the appearance of a traditional stile). Also available are narrow, ultra narrow and assymetrical configurations.



Available TruStile Product Options

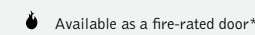

Available as a fire-rated door*

*Contact TruStile to confirm exact fire ratings and available sizes

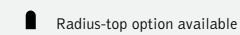

Radius-top option available

Common arch pair option available

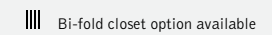

Bi-fold closet option available

Available in MDF only

TM Series Door Styles

Modern Panel Door Styles

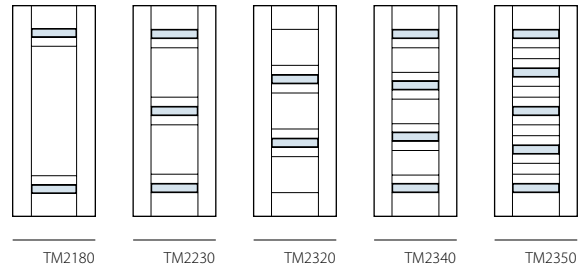

Note: Door styles are shown with the new modern wide stile. Shaded panels indicate an insert option: leather, metal, glass, resin or a flat mdf or wood panel.

Profile Options

TM Series modern panel designs are available with two profile options to frame your desired insert:

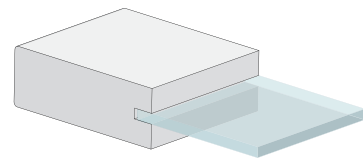

Square Stick (SS) Compression Fit

Compression fitting not available for leather inserts. Glass can not be replaced on compression fit doors.

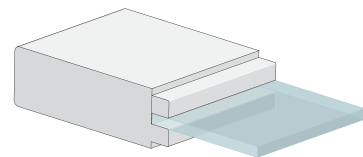

Square Stick (SS) Sash

Square Stick sash not available on MDF or wood used as a panel insert. Use One Step (OS) sticking to match Square Stick (SS) sash around wood inserts.



TM2180 in Rift Sawn White Oak with Ebony stain and White Lami glass inserts



TMUN3000 pocket doors in MDF with Square Stick (SS) sticking and Clear glass

TMUN Ultra-Narrow Door Collection

We have expanded our popular Tru&Modern series to include ultra-narrow door styles that bring an all new look to today's sleek interiors.

TMUN Series Door Styles

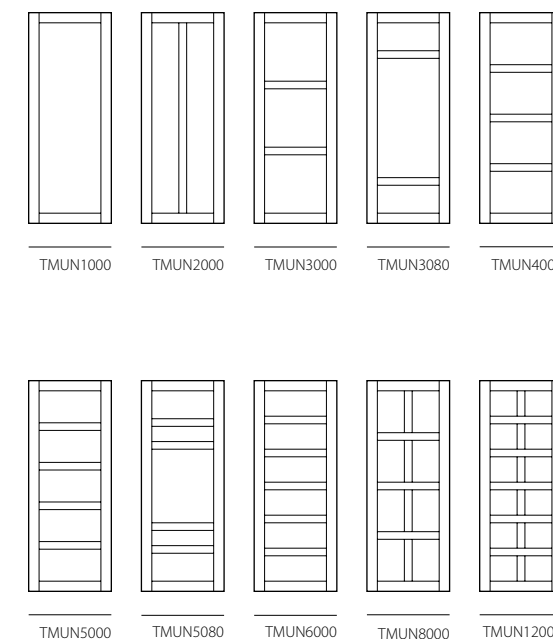

- Featuring 4" stiles and rails
- Select either MDF or one of our many standard wood species
- All panels can be substituted with glass
- We recommend narrow hardware sets and escutcheon plates with ultra-narrow doors

Profile Options

TMUN series door designs are available with standard panel door panel & sticking options, but Square Stick profiles are recommended to maintain the ultra-narrow aesthetic.

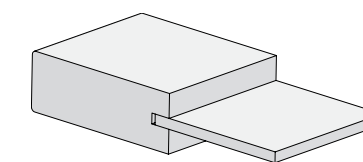

Square Stick (SS) Sticking

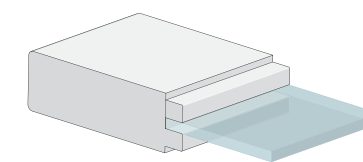

Square Stick (SS) Sash

Mix & Match Panels & Glass

Create a cohesive look throughout your home, while maintaining privacy where desired.



TMIR Series Door Collection

Modern architecture demands exacting specifications. The Tru&Modern Infinite Rail brings a luxurious level of sophistication with kerf cuts or metal inlays that traverse the complete width of the door.



TMIR6080 in Mahogany with Espresso stain and 1/2" Bright Stainless Steel inlay

TMIR Series Door Styles

Horizontal Reveal Doors

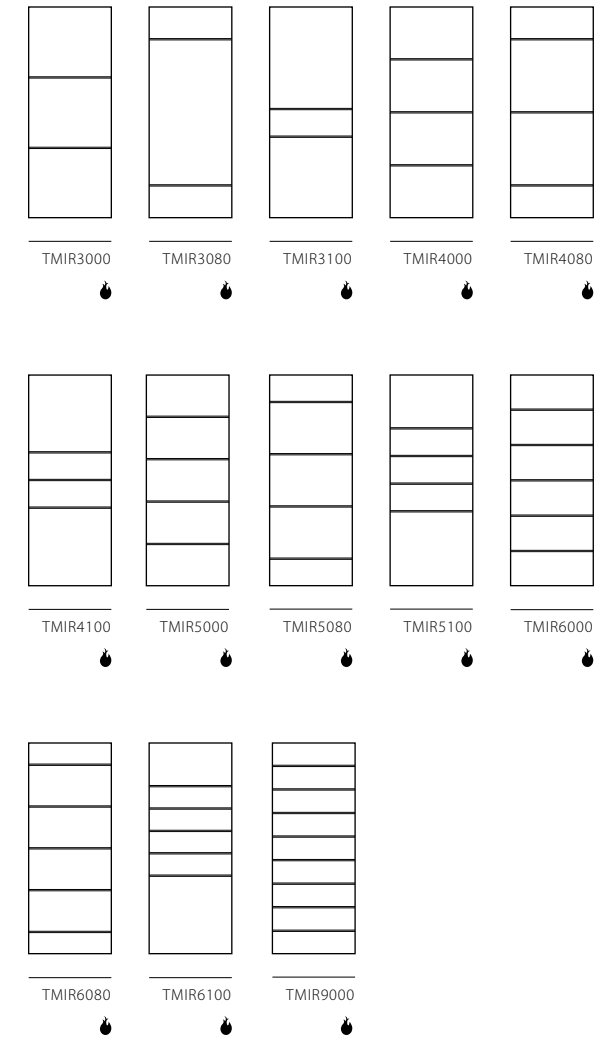

TMIR Reveal Options

TMIR horizontal reveal doors are available with the following reveal options:

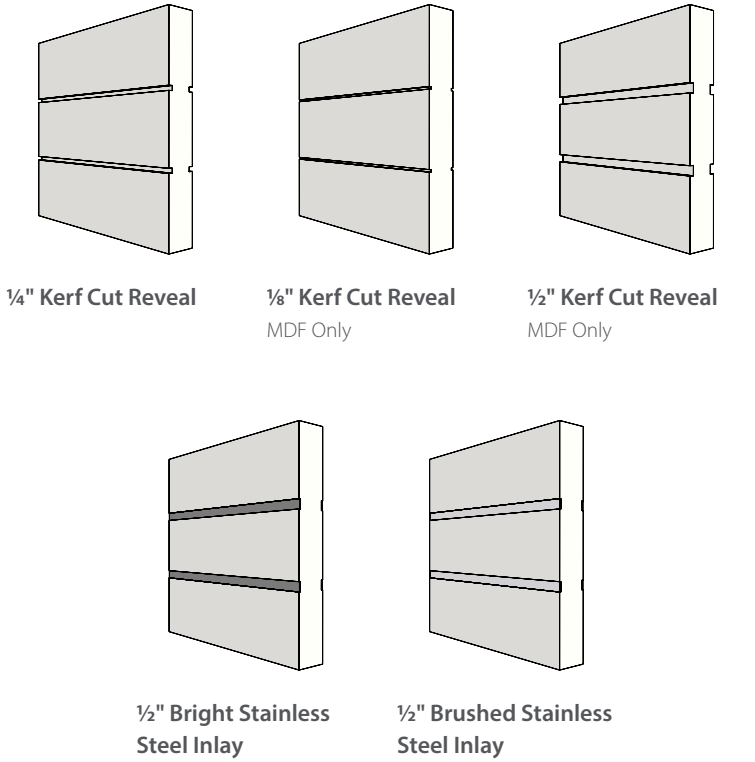

Available TruStile Product Options

Available as a fire-rated door*

Arch-top option available

*Contact TruStile to confirm exact fire ratings and available sizes

Radius-top option available

Common arch pair option available

Bi-fold closet option available

Available in MDF only



TMIR9001 in White Oak with Nutmeg stain and 1/4" Kerf Cut reveal

TMIR Series Door Styles

Vertical Reveal Doors

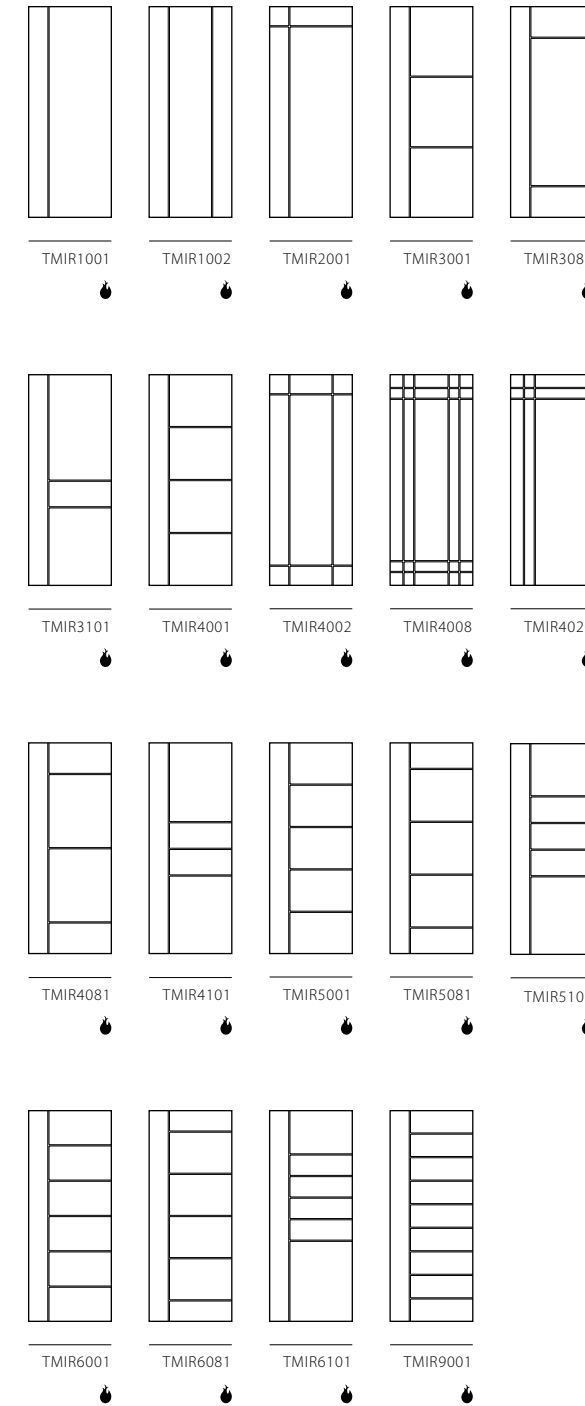

Reveal Options

TMIR vertical reveal doors are available with the following reveal options:

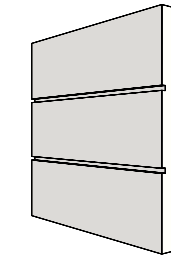

1/4" Kerf Cut Reveal

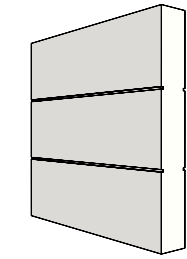

1/8" Kerf Cut Reveal
MDF Only

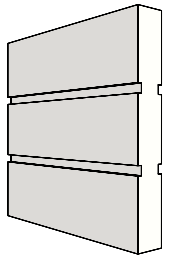

1/2" Kerf Cut Reveal
MDF Only

Available TruStile Product Options

Available as a fire-rated door*

Arch-top option available

*Contact TruStile to confirm exact fire ratings and available sizes

Radius-top option available

Common arch pair option available

Bi-fold closet option available

Available in MDF only

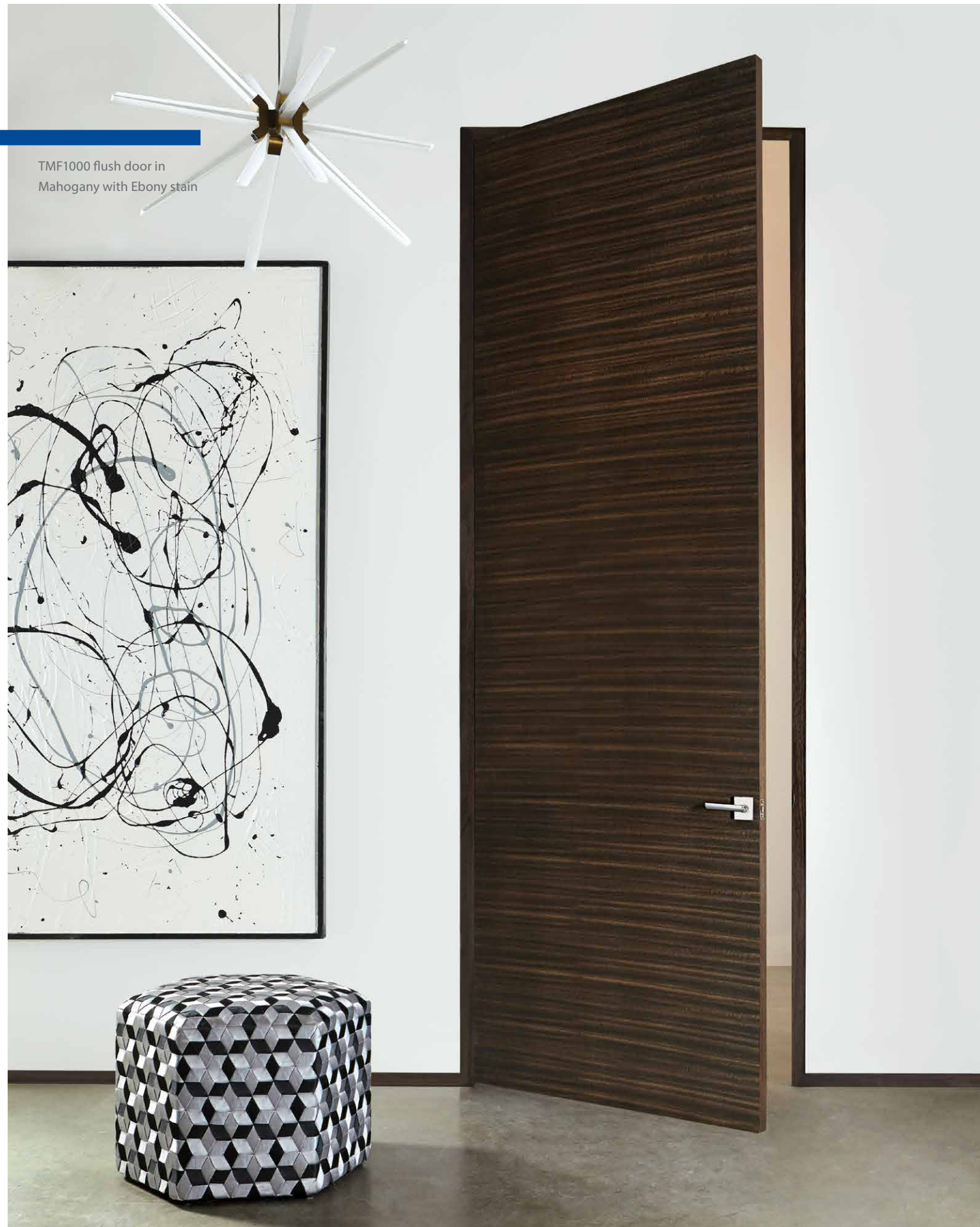

TMF1000 flush door in Mahogany with Ebony stain

TMF Series Flush Door Collection

All other flush doors just don't deliver the refinement required for today's modern interior. TruStile flush wood doors feature 1/16" thick hand selected veneers, precision matched to optimize the beautiful character found across each species of natural wood.

- Hand-matched 1/16" veneers are available in both horizontal and vertical grain.
- A highly engineered core provides stability for the door while the matching hardwood edge provides a beautiful finish.
- Made to order in sizes up to 4' x 10'.
- Available in over 15 standard species as well as paint-grade MDF.



TMF1000 in Plain Saw White Oak and Grey Mist stain



TMF1000 in Mahogany with Ebony stain

A Perfect Match

When hand matching veneers for pairs, TruStile treats the pattern as one extra wide door to ensure the grain looks its best across the width of the pair.

Achieve the Look

Modern is all about distinctive details and they don't stop at the door. TruStile offers a modern jamb system to match the species and finish of your door. Concealed hinges are available with everything fully prepped at the factory.



TMF1000 flush doors in Rift Sawn White Oak with Hazelnut stain

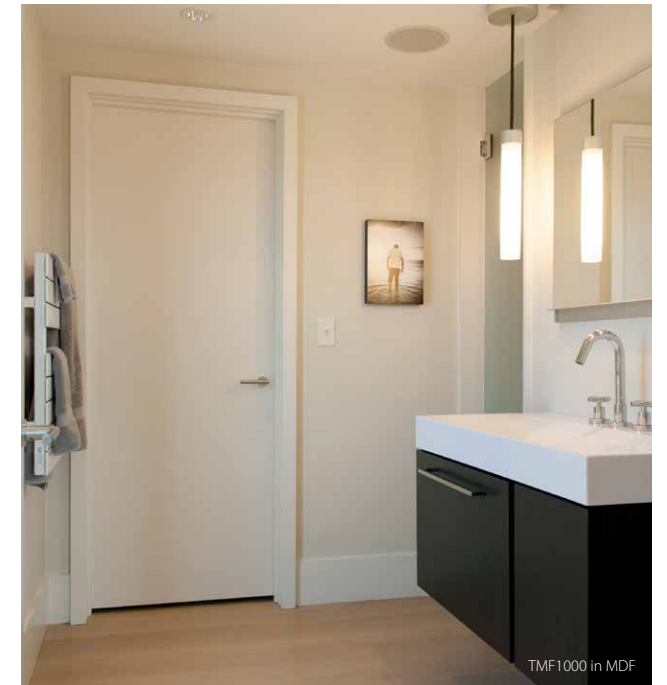

TMF1000 in MDF

MDF Flush Doors

- Highest quality, super-refined MDF creates a smooth paintable surface.
- A highly engineered core provides stability for the door while the patented Wedge Edge® provides a secure mount for hardware.
- Made to order in sizes up to 4' x 10'.

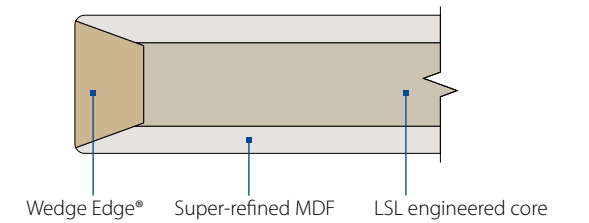

TMF1002 in Walnut and clear coat finish

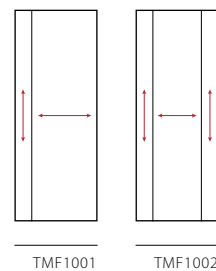

Sketch Face Doors

TruStile offers two door styles that combine hand-matched vertical and horizontal veneers on the same face. Our new Sketch Face designs can bring a new level of sophistication to your project.



TMF2200 in MDF

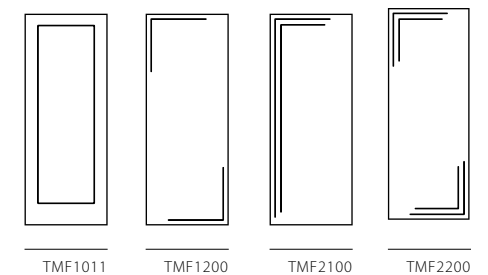

Accent on Simplicity

MDF flush doors feature four additional door styles that add subtle flourishes.

TMP Series Plank Door Collection

Create a contemporary version of this ageless design. Vertical planks with our ¼" kerf cut bring rich definition to modern design.

- Three kerf cut reveal options
- Choose from standard or wide plank spacing
- Made to order in sizes up to 4' x 10' in both wood or MDF

TMP Series Door Styles

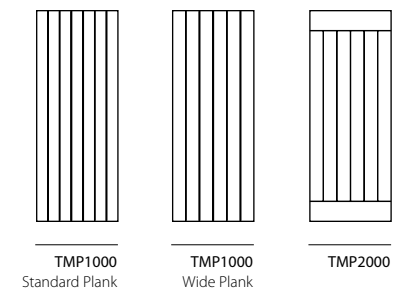

Reveal Options

TMP series modern plank doors are available with the following reveal options:

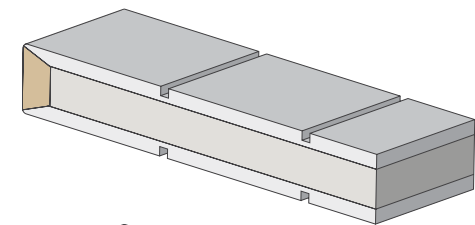

¼" Kerf Cut Reveal
Coordinates with other TM series door styles

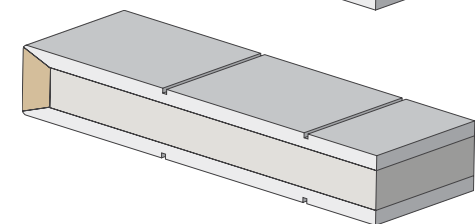

⅛" Kerf Cut Reveal
Creates a more subtle line
MDF Only

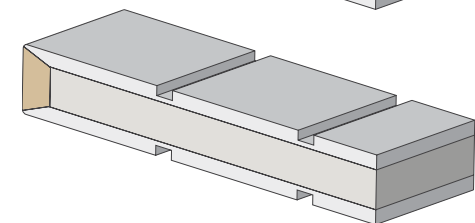

½" Kerf Cut Reveal
For a bold, strong line
MDF Only

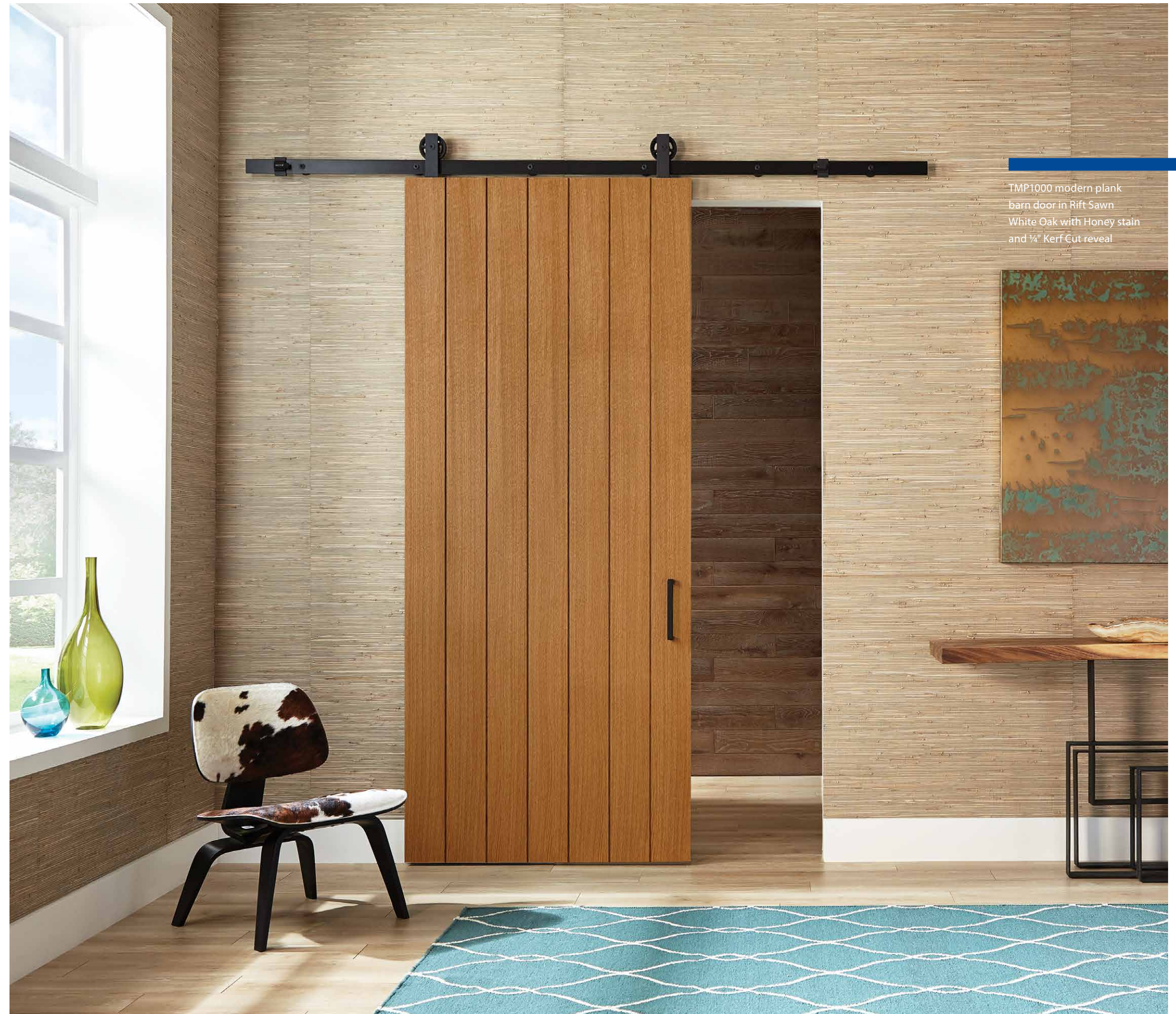

TMP1000 modern plank barn door in Rift Sawn White Oak with Honey stain and ¼" Kerf Cut reveal

FL Door Collection

Our French Door (FL) Collection offers 100 classic glass door designs from one- to 18-lite configurations. Our French Doors are crafted with true divided lites. Each individual piece of glass is hand-inserted for maximum architectural detail.

FL Series Door Styles

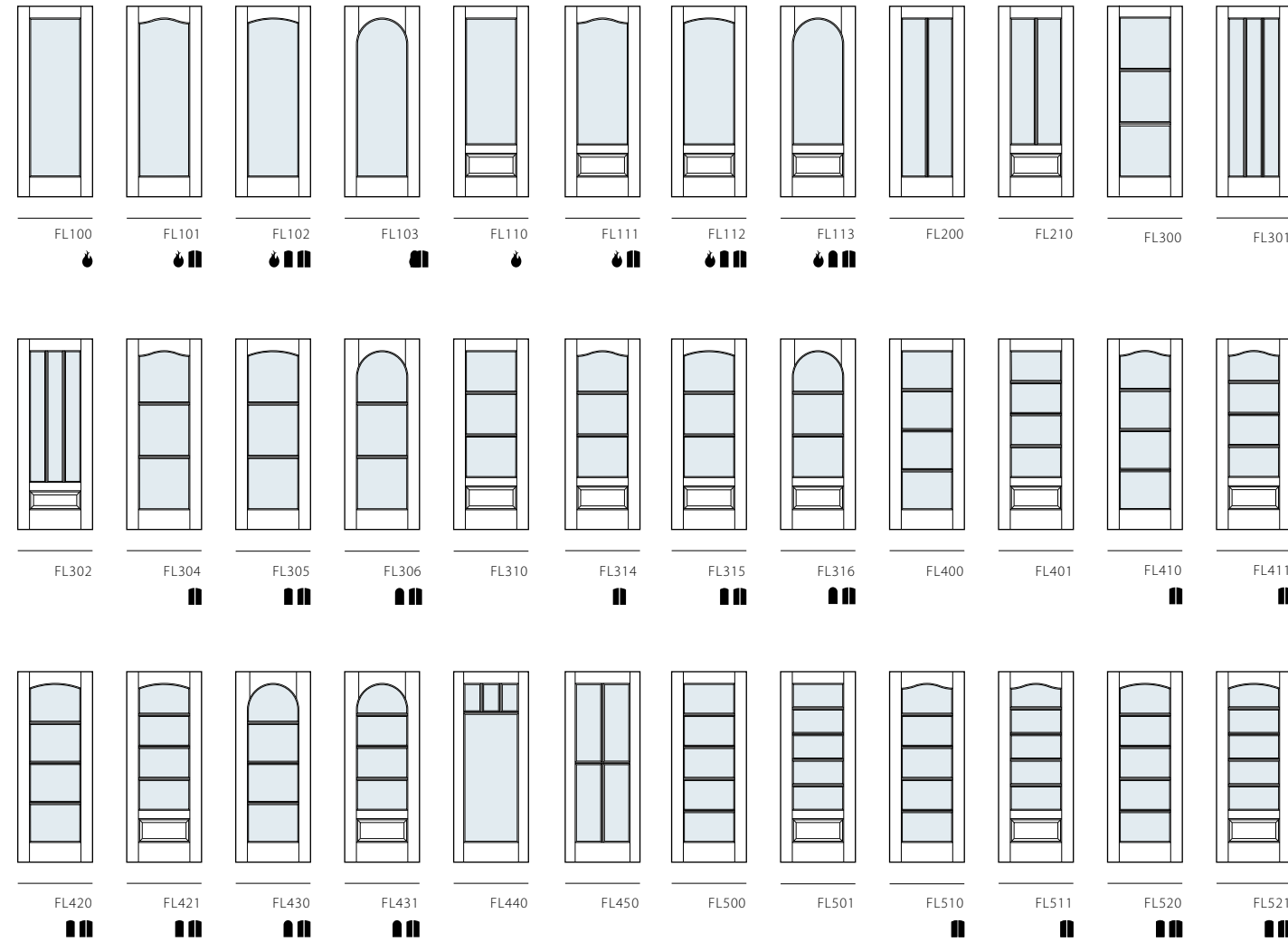

FL300 in MDF with One Step (OS) sash and Bevel glass



Available TruStile Product Options



Available as a fire-rated door*

Arch-top option available

*Contact TruStile to confirm exact fire ratings and available sizes



Radius-top option available

Common arch pair option available



Bi-fold closet option available

Available in MDF only

FL Series Door Styles

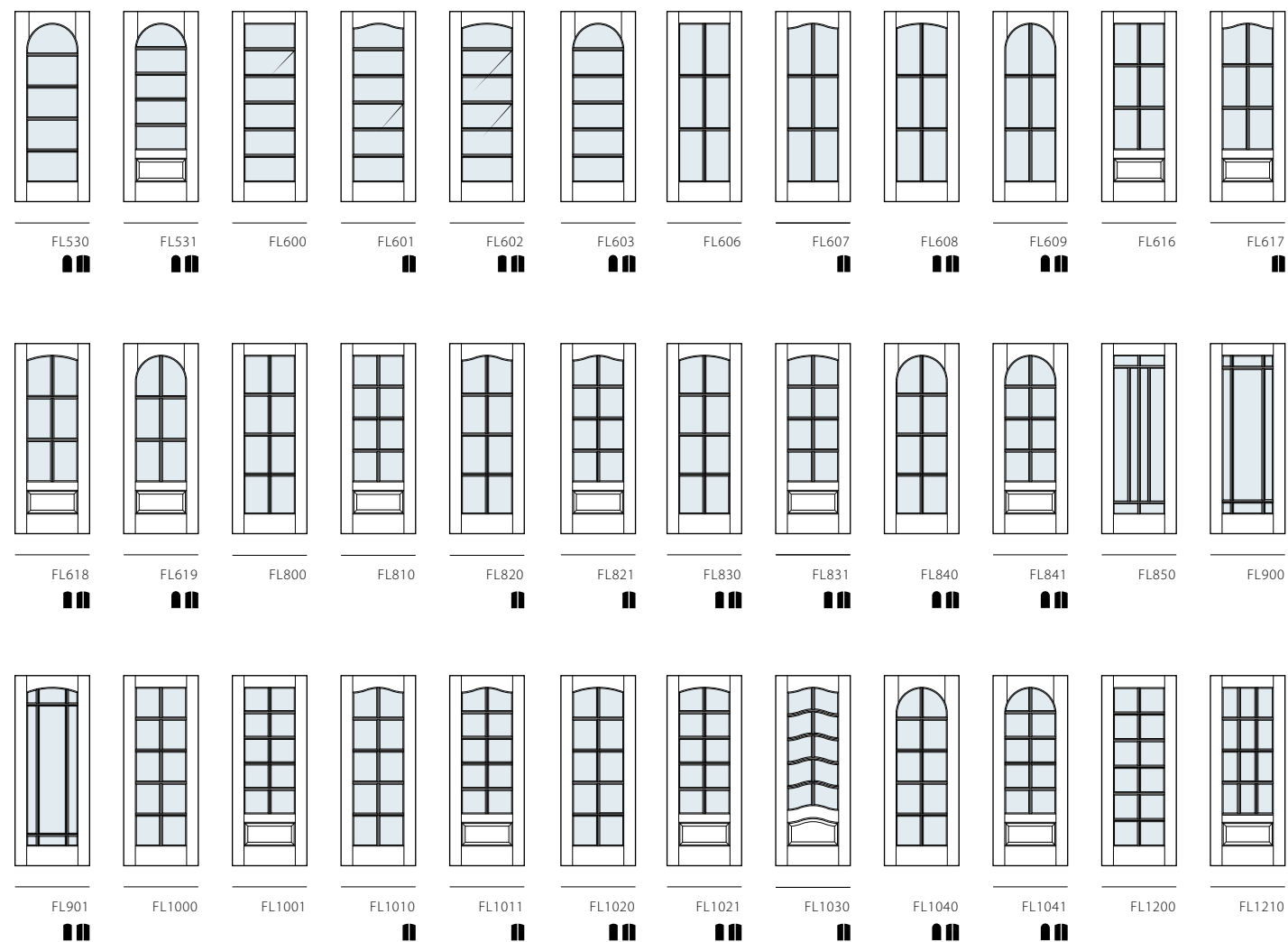

FL Series Door Styles

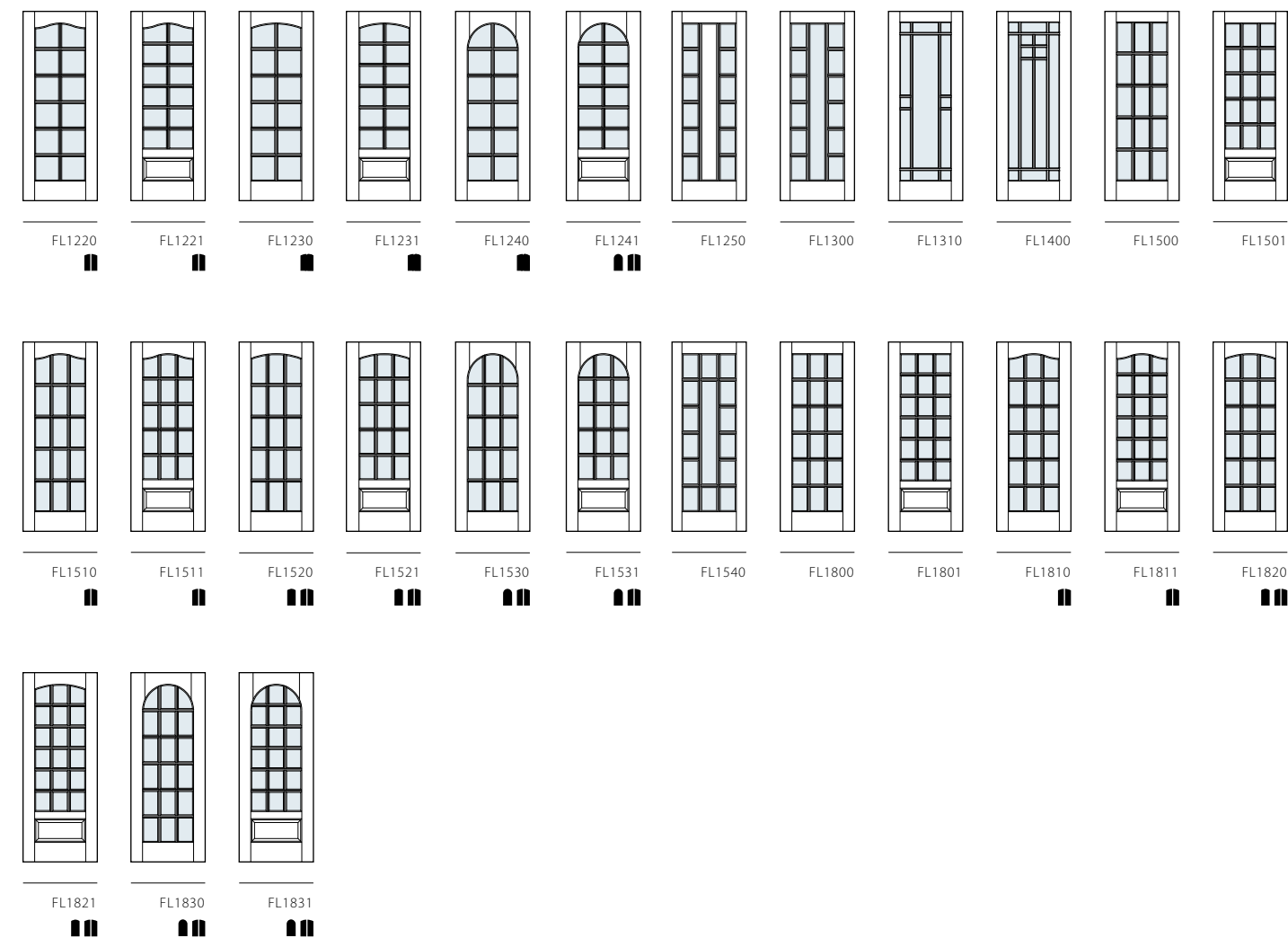

Available TruStile
Product Options

Available as a fire-rated door*
Arch-top option available
*Contact TruStile to confirm exact fire ratings and available sizes

Radius-top option available
Common arch pair option available

Bi-fold closet option available
Available in MDF only

PL Door Collection

Our Panel Lite (PL) Door Collection combines raised and flat panels with glass lites, giving you the best of both styles. A popular selection for pantries, bathrooms and entries, panel lite doors can be used for both interior and exterior applications.

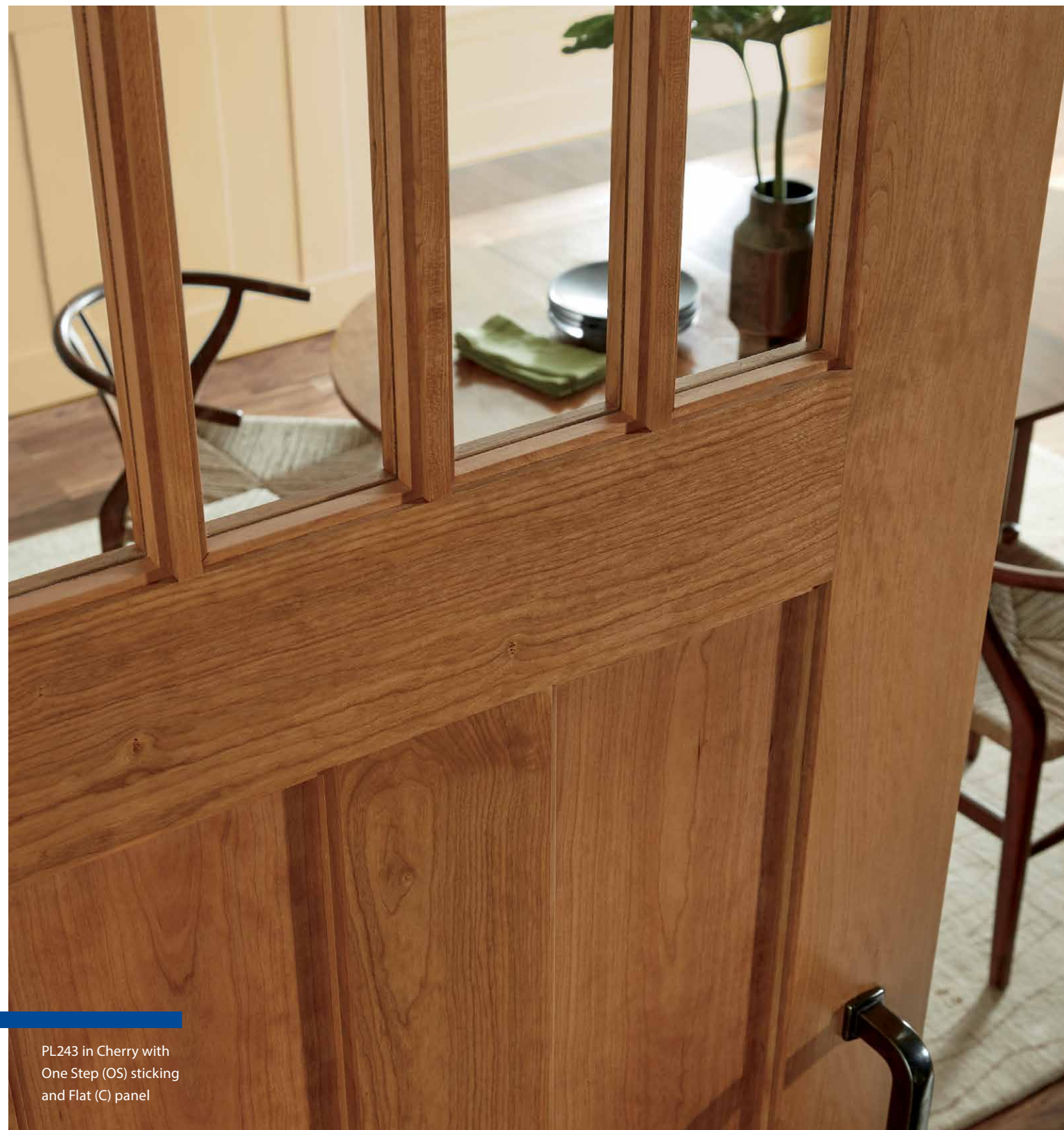

PL243 in Cherry with One Step (OS) sticking and Flat (C) panel

PL Series Door Styles

Available TruStile Product Options	Available as a fire-rated door* Arch-top option available <small>*Contact TruStile to confirm exact fire ratings and available sizes</small>	Radius-top option available Common arch pair option available	Bi-fold closet option available Available in MDF only
------------------------------------	--	--	--



TS2210 in MDF with Cove & Bead (CB) sticking, Flat (C) panel and White Lami glass

Glass Door Profile Options

The following sash and compression fit options are available to match our panel door profiles.

Reverse Roman Ogee (OG) Sash

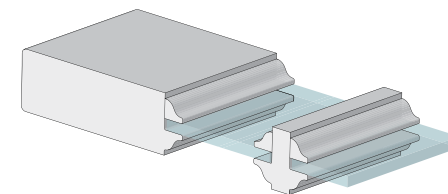

Narrow Reverse Roman Ogee (OG) Sash*

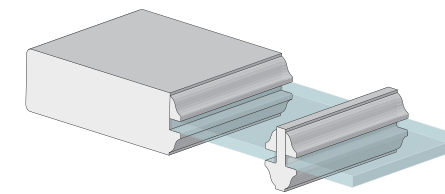

Cove & Bead (CB) Sash

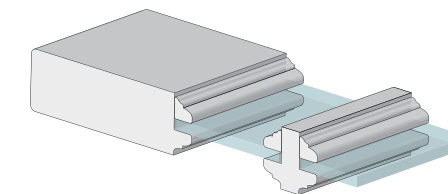

Quarter Bead (QB) Sash

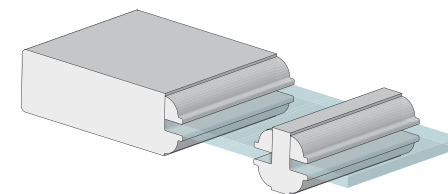

Quarter Round (QR) Sash

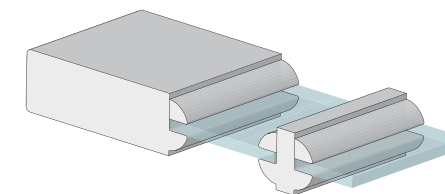

Bevel (BV) Sash

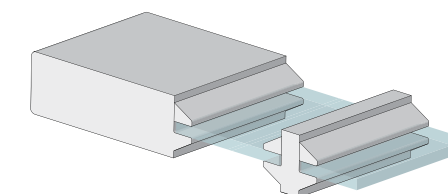

Square Stick (SS) Sash

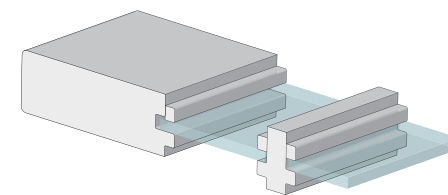

Square Stick (SS) Compression Fit**

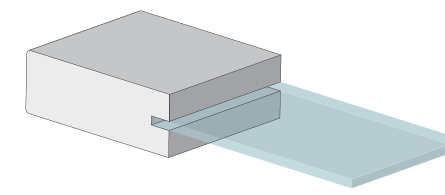

Quirk Moulding (QM) Compression Fit**

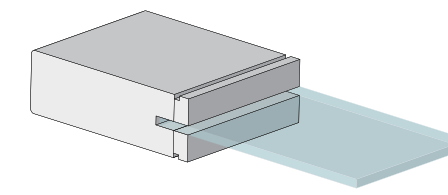

One Step (OS) Sash

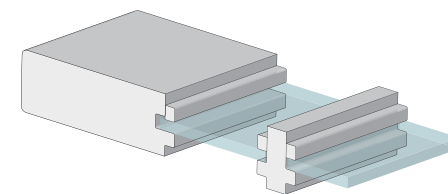

Applied Raised Moulding (ARM)

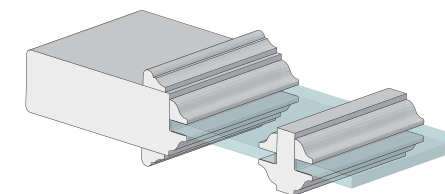

* Optional 3/8" narrow muntin bars available only on interior doors with 1/2" glass.

** On compression fit doors, glass cannot be replaced if broken.

V-Groove Door Collection

Our V-Groove (VG) Door Collection features a tongue-and-groove look that emulates plank doors. Each door is built with genuine stile and rail construction to ensure greater performance than plank doors.



VG4010 barn door in Wire Brushed White Oak

VG Series Door Styles

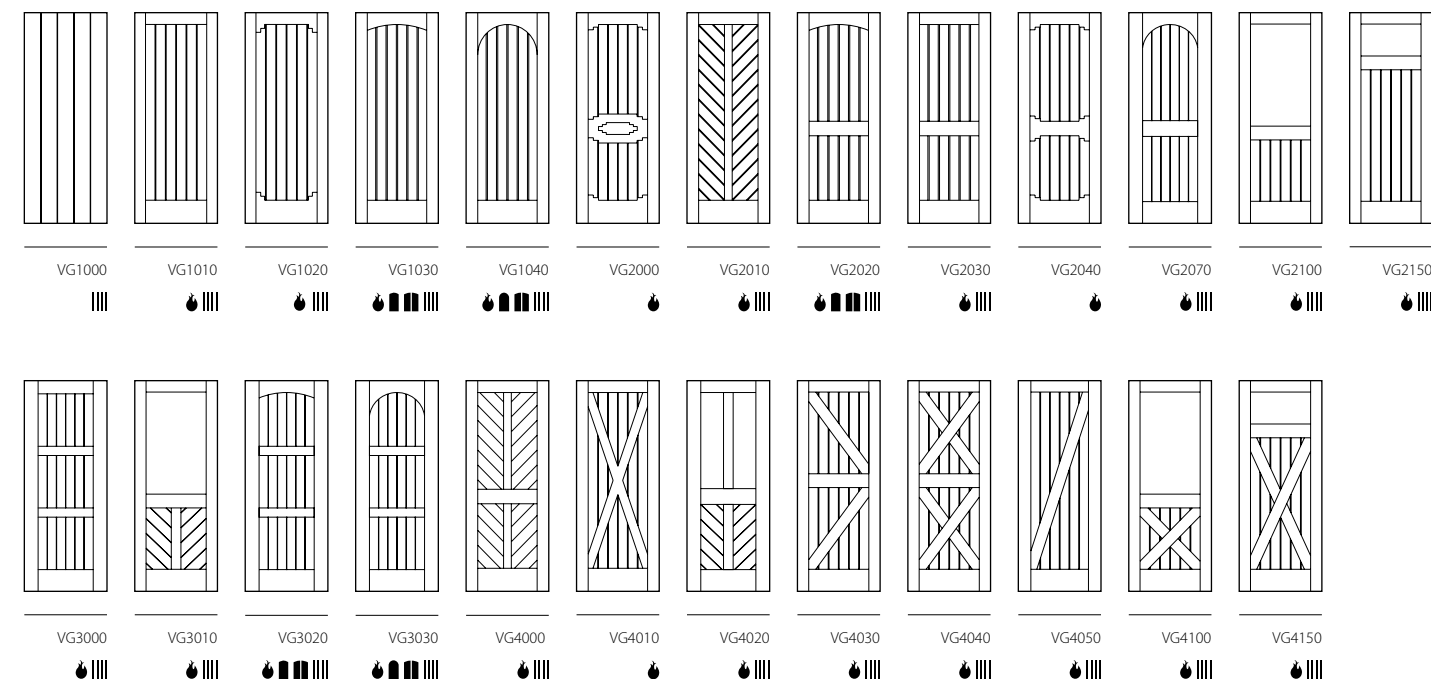

Plank Door Profiles (VG1000)

Plank doors are available with standard and wide plank spacing and the following profiles:

Standard V-Groove Profile

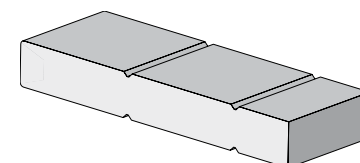

Wide V-Groove Profile

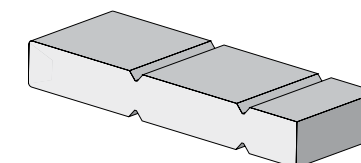

V-Groove Series Profiles

V-Groove doors come with one of the following standard profiles:

Standard V-Groove Profile

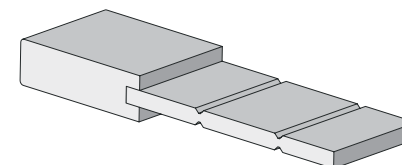

Beaded V-Groove Profile (Optional)

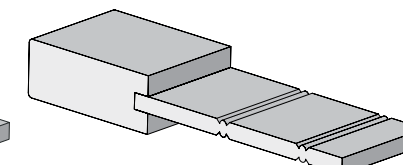

Available TruStile Product Options

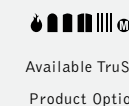

Available as a fire-rated door*
Arch-top option available

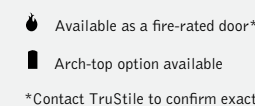

Radius-top option available
Common arch pair option available

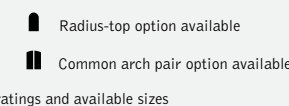

Bi-fold closet option available
Available in MDF only

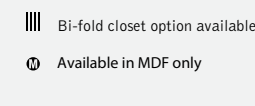

*Contact TruStile to confirm exact fire ratings and available sizes



Tambour Door Collection

Our Tambour (TMB) Door Collection combines stile and rail construction with state-of-the-art CNC routing technology to create a uniquely contemporary look. Combine these doors with other styles for design interest and visual variety.

Tambour Door Profile Options

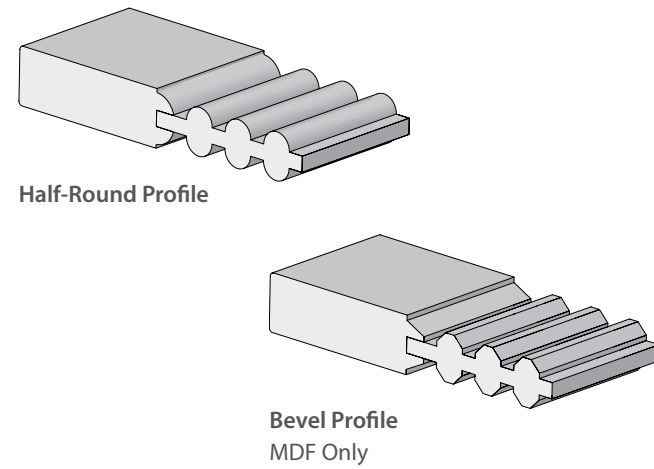

Tambour Door Styles

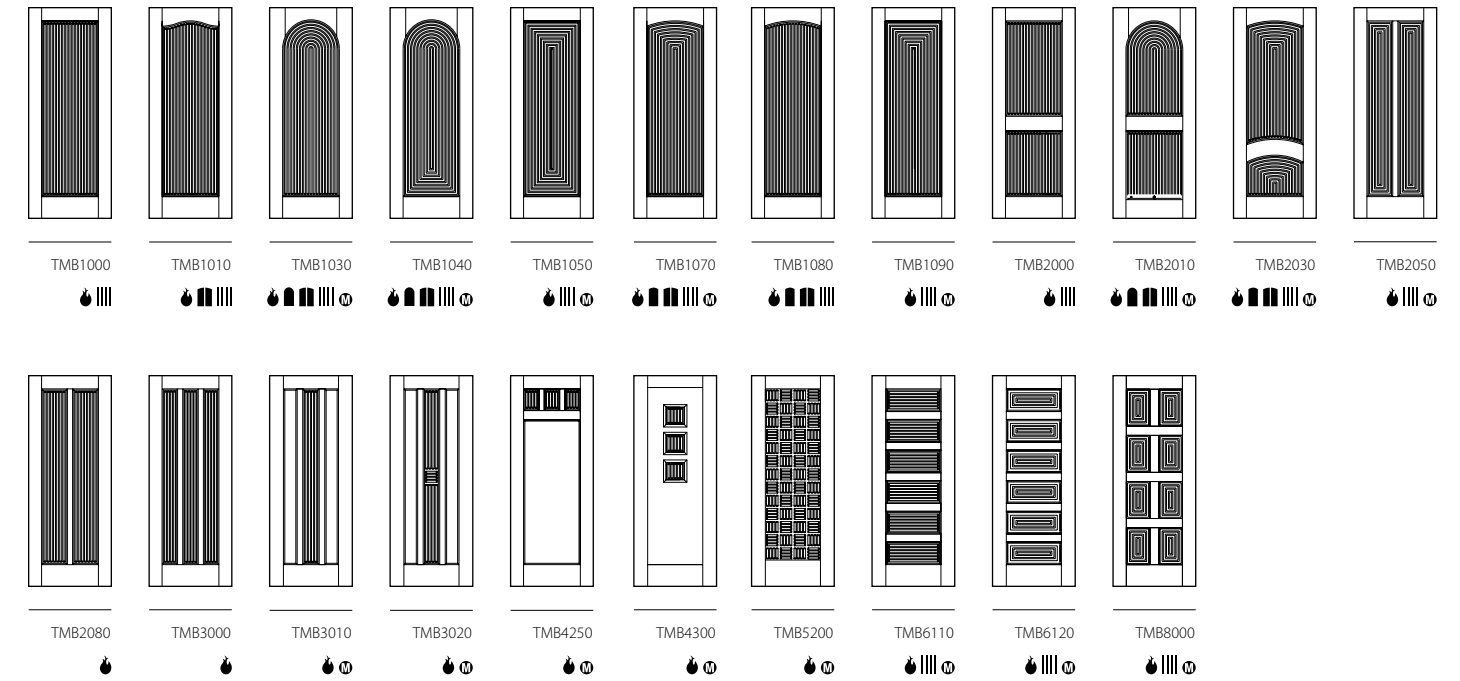

Custom Design Door Collection

Our Custom Design (CD) Collection features an eclectic mix of custom styles from our design team. These exclusive TruStile designs fulfill a variety of architectural styles and are perfect for creating a dramatic visual impact. TruStile's Custom Design Collection proves that doors can be just as exciting as other home design elements.



CD Series Door Styles

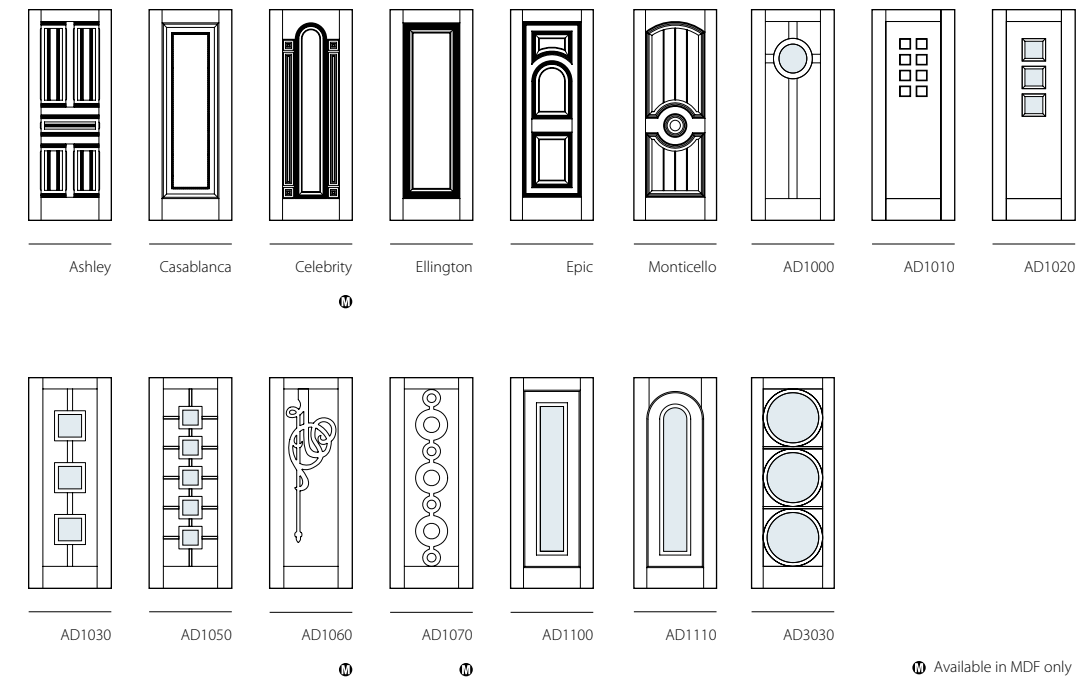

Available in MDF only

Louver Door Collection

Our Louver (LVR) Door Collection creates architectural interest and enhances a variety of styles. These plantation-style louver doors feature fixed, over-sized louvers in vented and false configurations.



LVR1000 barn doors in Walnut with false louver panels

Louver Door Profile Options

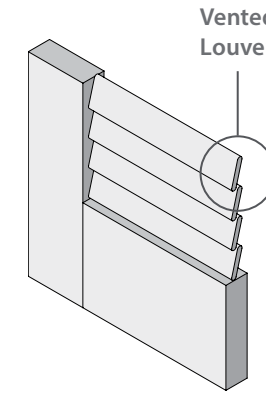

Vented Louver Doors

Vented louver doors permit air flow making them ideal for closets and laundry rooms where ventilation is preferred.

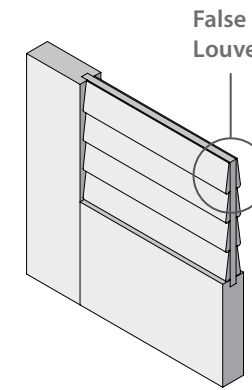

False Louver Doors

False louver doors are ideal for applications where the appearance of a louver panel desired, but total privacy is needed.

Both vented and false louver slats are 2"



LVR2020 in MDF

Louver Door Styles

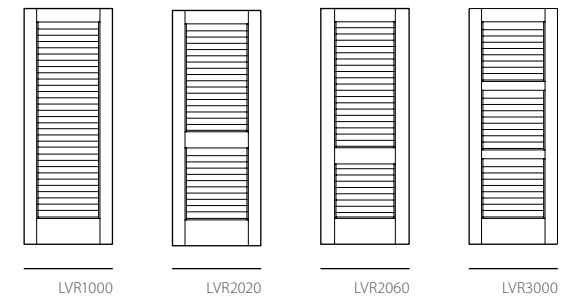

LVR1000 LVR2020 LVR2060 LVR3000

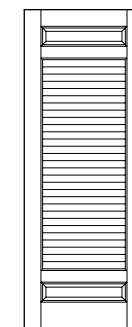

Create Your Own Louver Door

Louver panels can be added to most door styles with a rectangular panel (minimum size requirements apply). The example on the left features a TS3080 with a middle false louver panel.



TS3080 in Mahogany with Roman Ogee (OG) sticking, Raised (A) panel and louver panel added to center

Interior Transoms

Open up interior spaces by allowing in more natural light . Interior glass and panel transoms provide more options for beautiful, dramatic openings.



TRG100 transom in paint grade MDF above a pair of FL300 barn doors in Clear Pine with Champagne stain and Bevel glass

Glass Interior Transom Styles



- Both glass and panel designs available
- Wide range of made-to-order sizes available in wood or MDF
- Order with multiple alignment options with or without a 4-sided jamb

Panel Interior Transom Styles

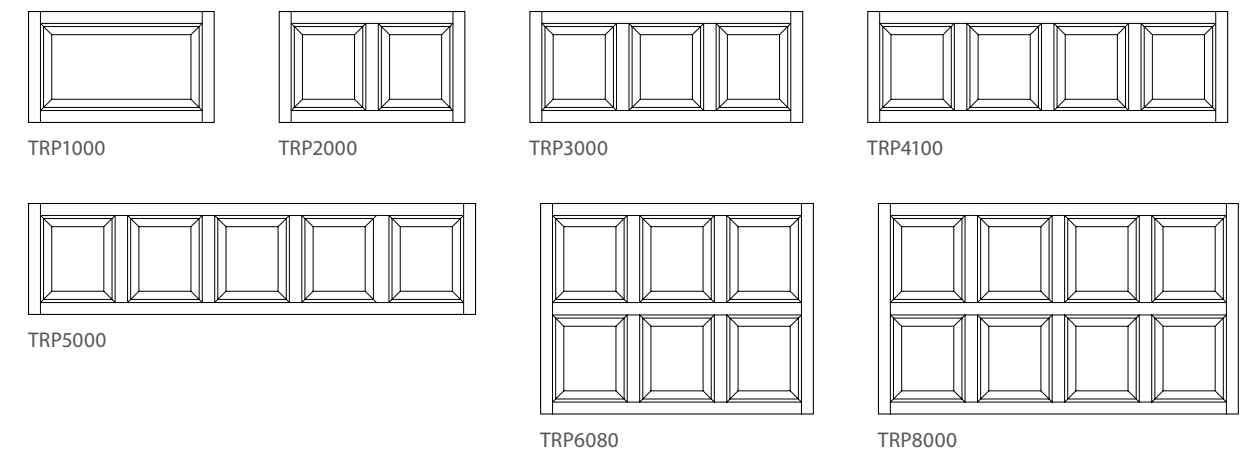

Door Design Tool

Configure multiple doors and organize them by project

TruStile's exclusive web-based software allows you to design your own custom doors. Specify the height, width and location of all components within a door.



Export door schedules, drawings or CAD files to import into your plans

Create multiple doors and organize them by project

Over 500 door styles to customize to your needs — available as interior or exterior, pre-hung units or slabs.

An accurate preview is continually updated as you make changes to your door design.

Line #	Door Label	Qty	Product Type	Opening Type	Material
1	Study	2	Interior Door	Swing- Single	Walnut
2	Game Room	1	Interior Door	Swing- Pair	Walnut
3	Laundry	1	Interior Door	Swing- Single	MDF
4	Master Bedroom	1	Interior Door	Swing- Pair	Walnut
5	Master Bath	1	Interior Door	Swing- Single	MDF
6	Master Bath: WC	1	Interior Door	Pocket- Single	MDF
7	Guest Bedroom 1	1	Interior Door	Swing- Pair	Walnut
8	Guest Bedroom 2	1	Interior Door	Swing- Single	Walnut
9	Guest Bedroom 1: Closet	1	Interior Door	Barn- Pair	MDF
10	Guest Bedroom 2: Closet	1	Interior Door	Sliding- Pair	MDF
11	Guest Bedroom 2: Bath	1	Interior Door	Swing- Single	Walnut
12	Guest Bedroom 2: WC	1	Interior Door	Pocket- Single	MDF

Share Your Project with Other Apps

Door Design Tool projects can be exported as a door schedule that opens directly in Microsoft® Excel, as PDF of drawings or CAD models to import directly into your plans.

www.trustile.com/designtool



TM9440 pocket door in MDF with Shoji glass

This Page: TMF1000 flush doors
in Plain Sawn White Oak
with Grey Mist stain

Front Cover: TM9340 doors in Walnut
with Nutmeg stain and
Shagreen Café Latte leather



TRŪSTILE[®]
A MARVIN  BRAND

FOLLOW US



www.trustile.com

TRUSTILE DOORS, LLC

1111 E. 71st Avenue
Denver, CO 80229

888.286.3931



Copyright © 2021, TruStile Doors, LLC. All rights reserved.
Select hardware provided by Emtek Products, Hafele America and Rocky Mountain Hardware.

v05142121